

electronics

radio, communication, industrial applications of electron tubes . . . engineering and manufacture



Electronics explores
the stratosphere
(See page 31)

DECEMBER
1935

Price
50 Cents

McGRAW-HILL
PUBLISHING
COMPANY, INC.

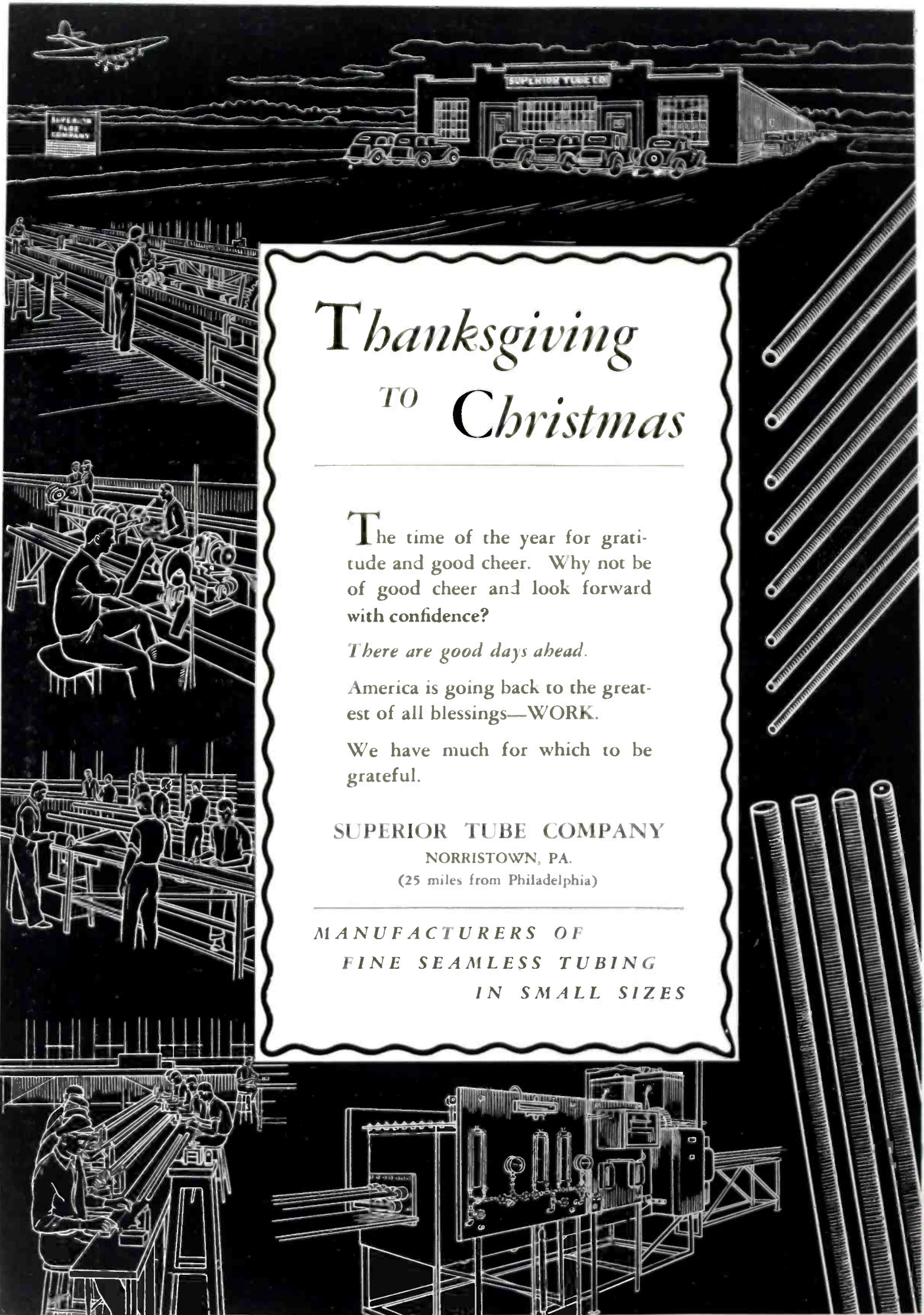

Thanksgiving TO Christmas

The time of the year for gratitude and good cheer. Why not be of good cheer and look forward with confidence?

There are good days ahead.

America is going back to the greatest of all blessings—WORK.

We have much for which to be grateful.

SUPERIOR TUBE COMPANY

NORRISTOWN, PA.

(25 miles from Philadelphia)

MANUFACTURERS OF
FINE SEAMLESS TUBING
IN SMALL SIZES

ELECTRONICS

radio, communication and industrial applications of electron tubes . . . design, engineering, manufacture

HOWARD EHRLICH
Vice-President

KEITH HENNEY
Editor

DONALD G. FINK
Associate Editor

H. W. MATEER
Manager

CONTENTS

December 1935

THE COVER: Captain Stevens preparing for the Stratosphere Flight	
Photograph by Robert M. Morris, Development Engineer of the NBC, whose transmitting antenna is held aloft by the small balloon	
THE ULTRA-SPEED CAMERA	7
A new type of high-speed camera takes pictures at 3000 per second, times them electronically, provides added insight into industrial processes and technique	
FALL MEETING, INSTITUTE OF RADIO ENGINEERS	11
Report of papers delivered at Rochester, November 18-20 of particular interest to radio set and tube engineers. Candid photographs of those in attendance by Leslie F. Woods (Plaibel Makina) and the editors (Leica)	
ELECTRONICS IN OIL	15
Aside from geophysical apparatus there are many uses for electron tubes in the business of finding, refining, testing and using oil	
HIGH GAIN SIMPLIFIED by PAUL VON KUNITS	18
Designing a high gain microphone amplifier with a minimum of parts and tubes, including the newly announced grid-bias cell	
HIGH SPEED RADIO PRODUCTION , by P. H. JERYAN	21
5,000 sets a day roll from the production lines at RCA Victor at Camden where all manner of other electronic equipment is manufactured. The processes of quantity radio production is described by word and picture	
SELF-PROTECTING CATHODES , by DR. E. F. LOWRY	26
A new development of interest to users of hot cathode mercury vapor types of rectifiers and controlled tubes	
DR. G. A. CAMPBELL RETIRES	28
POWER SUPPLY FILTER DESIGN , by W. W. WALTZ	29
Relation between capacity and inductance for desired hum levels	
ELECTRON TUBES IN STRATOSPHERE FLIGHT	31
Data on the electronic apparatus as described by Dr. W. F. G. Swann and Dr. G. L. Locher of the Bartol Research Foundation, Dr. O. H. Gish of the Carnegie Institution of Washington and Mr. Robert Morris of the National Broadcasting Company	
LIGHT-SENSITIVE CELL CIRCUITS	36
Data collected by Mr. Samuel Wein, well known for his extensive knowledge of the past art in this field. Circuits described are restricted to the dry-type of self-generating cell	
"PROOF-READ" RECORDING	39
A piezo-crystal cutter engraves high fidelity records directly on aluminium, permitting immediate playback, monitoring from the master record during the performance	

DEPARTMENTS

CROSS-TALK	5	MANUFACTURING REVIEW	48
VIEWS AND REVIEWS	35	PATENT REVIEW	56
THE ELECTRON ART	42	INDEX TO ADVERTISERS	68

INDEX TO VOL. VIII (Jan.-Dec. 1935 Incl.) 61

VOLUME 8 . . . NUMBER 12.

Contents Copyright, 1935, by McGraw-Hill Publishing Company, Inc.

ELECTRONICS, December, 1935. Vol. 8, No. 12. Published monthly, price 50c. a copy. Subscription rates—United States, \$5.00 a year. Latin America, \$5.00 a year. Canada, including duty, \$5.50 a year. All other countries, \$6.00 a year or 24 shillings. Entered as second-class matter April 4, 1930, at Post Office at New York, N. Y., under the Act of March 3rd, 1879. Printed in U. S. A. Printed by The Schweinler Press, N. Y.

Branch Offices: 520 North Michigan Ave., Chicago; 883 Mission St., San Francisco; Aldwych House, Aldwych, London, W. C. 2; Washington; Philadelphia; Cleveland; Detroit; St. Louis; Boston; Atlanta, Ga.

McGraw-Hill Publishing Company, Inc.
330 West 42d Street, New York, N. Y.

JAMES H. MCGRAW, Chairman of the Board
 MALCOLM MUIR President JAMES H. MCGRAW, JR. Executive Vice-President HOWARD EHRLICH Vice-President B. R. PUTNAM Treasurer D. C. MCGRAW Secretary

Cable Address: MCGRAWHILL, New York. Member A.B.P. Member A.B.C.



WE CAN CUT ASSEMBLY
TIME BY USING
ERIE *Insulated* RESISTORS
IN THESE PLACES

ERIE

*Space
Saving*

INSULATED RESISTORS

ERIE RESISTOR CORP.
TORONTO, CAN. ERIE, PA. LONDON, ENG.

Set manufacturers are discovering that space-saving Erie Insulated Resistors simplify chassis arrangement with consequent reduction in assembly costs.

This feature, plus over-all ceramic insulation makes point-to-point wiring practical and eliminates the necessity of a central resistor mounting strip.

Let us show you how Erie Insulated Resistors can help lower your production costs.

ELECTRONICS

DECEMBER
1935

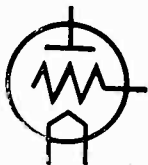

KEITH HENNEY
Editor

Crosstalk

► **CHISELERS ALL?** . . . We have recently interviewed many of those who supply component parts to the radio industry. We have been in the plants of more than a few, we have seen the marked activity, have heard of the steady demand, starting earlier and lasting longer this season than usual. One would think the parts suppliers would be happy, in fact as happy as the set manufacturers who are experiencing the largest season (and profits) since 1929.

But the facts are that these parts people are not happy. They agree almost unanimously that they cannot deal on a profitable basis with their customers. They state that the practices of purchasing agents who work every imaginable scheme to wrangle lower prices have not only taken away all visions of profit but have made it impossible to devote any time and money to the development of new materials or products.

The facts, then, are that while the set manufacturers are enjoying a boom in which the purchasers are buying higher priced receivers and in which the set makers are producing profits, the components manufacturers still are in a depression. One portion of the industry makes its money by squeezing another.

There is another angle to this situation. Lists have been made up of the worst offenders in this chiseling game. These lists made up by several parts manufacturers' sales departments coincide remarkably well. The larger purchasers apparently are among the worst of the price hagglers. Then we have had lists made up by several service men showing which receivers are most often in the shop for repairs. The coincidence is almost too good. These service men can tell you what set in a line goes bad, and how soon after purchase this receiver will be in the shop for a new resistor, condenser or what not.

A bit of detective work would probably reveal a sorry series of events

leading from the purchase of the part in question on a price basis, probably sold at less than cost to get the order, straight to the consumer who pays for the set maker's niggardness.

With public buying of higher priced radios, with general belief that new receivers are better and less likely to go wrong, with radio as an industry depending upon research and engineering, it seems that some of the profits should be allowed the parts manufacturer. Research into materials and components is as important as research into new tubes and circuits.

Consumer acceptance must rest on a foundation of good quality merchandise sold at a fair price with a guarantee of freedom from expensive upkeep.

► **B.L.R., also B.S.T.J.** . . . The following letter from Mr. Paul Findley, Managing Editor of the Bell Laboratories Record explains itself. "In the list Periodicals of the World, (See page 50, September, 1935, *Electronics*) along with A.E.G. Mitt. and Arkiv f. Mat. why not list *Bell Laboratories Record*?"

Or are we just beneath the notice of people who read E.N.T. and E.u.M.?" Fortunately, we did list another well and favorably known Bell System periodical, familiarly called the B.S.T.J.

► **APOLOGIES** . . . Major Behar, Editor of *Instruments*, the magazine of Measurement and Control, congratulates *Electronics* for having two editorial scoops in a given issue (November) a publisher's and editor's dream. These were the Zworykin and the Armstrong stories, written at great pressure by the staff. Then Mr. Behar points out that on page 24 of the same issue appears an error. It seems that in the Wells-Gardner drive mechanism drawing a pulley is labeled an "idler" and the true idler of the device has no label at all. To a mechanical engineer it seems that an idler does not work but, as in this case, merely keeps the belt taut.

► **PATENT SHAKE-UP** . . . Seriously considering abolition of the patent system but finally deciding that reform was the better medicine, the President's science advisory board patent committee recommends several most important changes in present patent procedure. Under the direction of Dr. Vannevar Bush, vice president and dean of engineering at M.I.T., the committee studied present abuses of the system and advocates the following changes.

1. Patent applications should be published in the Official Gazette as at present, but before and not after the patent is granted. After a limited time for interference to appear the patent would be issued, but all prior matter would have a chance to appear and to be cleared up before issuance. Thousands of duplications and re-patentings would be eliminated, much patent litigation would be side-tracked at the source, and the whole process through the patent office would be speeded up with obvious improvement.

2. A special patents court should be set up with the bench filled by judges equipped technically as well as legally with the proper understanding of the matters to be decided upon. A corps of specially trained advisers would be created for expert aid.

3. Patents should be classified better than at present so that complex machines, radio apparatus for example, should receive attention commensurate with their complexity and the labor and expense put into their creation.

Other recommendations of interest are the proposal that Patent Office searchers be given opportunity to visit industrial plants for their own better training; that an annual tax be placed upon all patents issued, so that those which are dormant would no longer clutter up the records.

► **"MATTER"** . . . says Percy A. Campbell describing neutrons and other recent physical concepts "exists because something is the matter with space."

Ultra-speed

Photoanalysis by means of accurately timed, ultra-rapid picture sequences is a new and important research tool

IT is only within the past three or four years that industrial managers have recognized the possibilities of motion picture photography in the improvement of industrial processes. But with each new application of this tool the importance of high speed photographic technique has become more apparent. Although

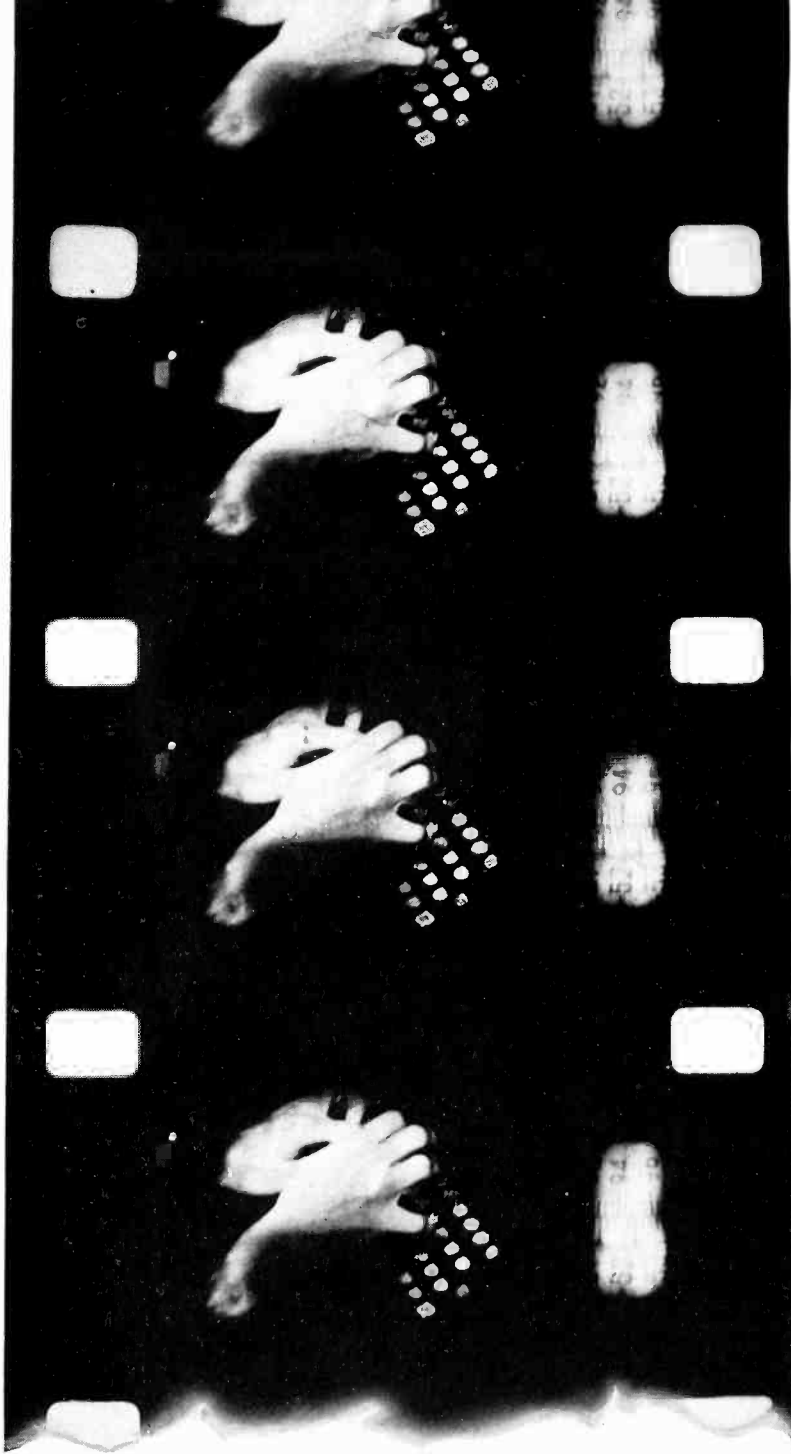

Keyboard Contrast

The finger action of two typists compared by pictures taken at 800 per second. The hands at the right are those of a highly expert operator, typing at full speed. Above, in contrast, are the fingers of a typical office worker, whose strained action is not visible to the eye. Revealed by the camera, it was analyzed as the cause of fatigue and inaccuracy

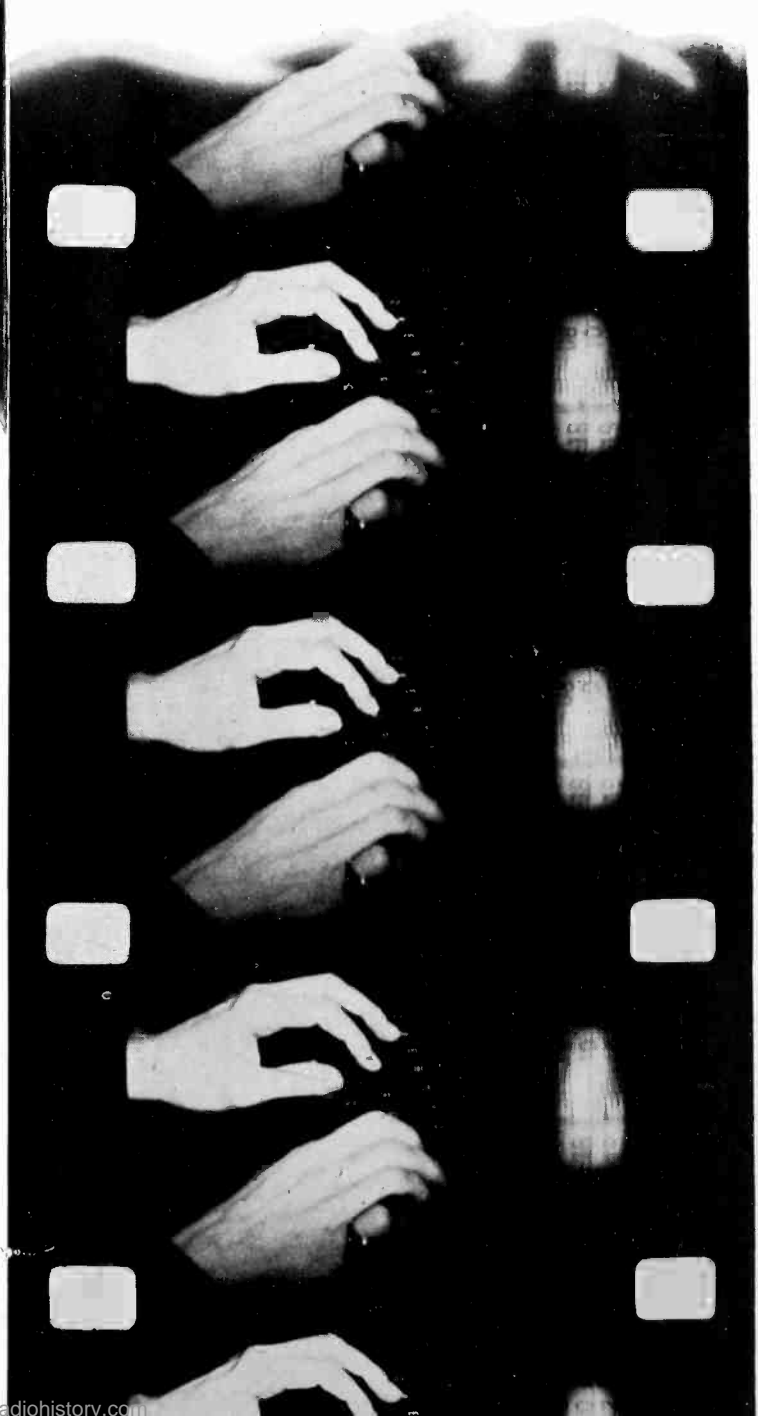

in Motion Pictures

A new high speed camera, plus an electronic timer, analyzes the motion of high speed industrial processes, tests machinery, and products, with resulting improvements and lowered costs; can produce pictures at 3,000 per second

the results of high speed photography have been well publicized, as witness the unusual pictures taken by Professor Edgerton of M.I.T. which have appeared recently in national advertising, the methods of taking these pictures are not well known. One of the high speed motion picture cameras used has already been described in *Electronics* (August, 1934, p. 260.)

A new camera known as the "Ultra-Speed Camera" which does not depend upon stroboscopic light for its action, and which is finding increasing use in all manner of industrial testing and design, has been developed jointly by the Eastman Kodak Company and the Bell Telephone Laboratories. The camera is primarily mechanical in operation and hence cannot be termed an electronic device, although it makes use of a highly accurate electronic timer in certain applications. Furthermore it can be used for solving problems which are often put before the electronic engineer. For this reason and also because most electronic engineers are camera enthusiasts, the following description of the high speed camera and its application is presented here.

The camera was developed originally for the timing of racing events in the sports world. For this purpose electrically operated time dials, started by the pistol which started the race, were photographed by the camera at the same time that photographs of the finish of the race were taken.

The camera, in its present state of development, is capable of producing pictures as fast as 3,000 per second, and of recording time in connection with these pictures to the nearest thousandth of a second. Those familiar with motion picture photography will know that this rate of picture-taking represents a real achievement. It has been made

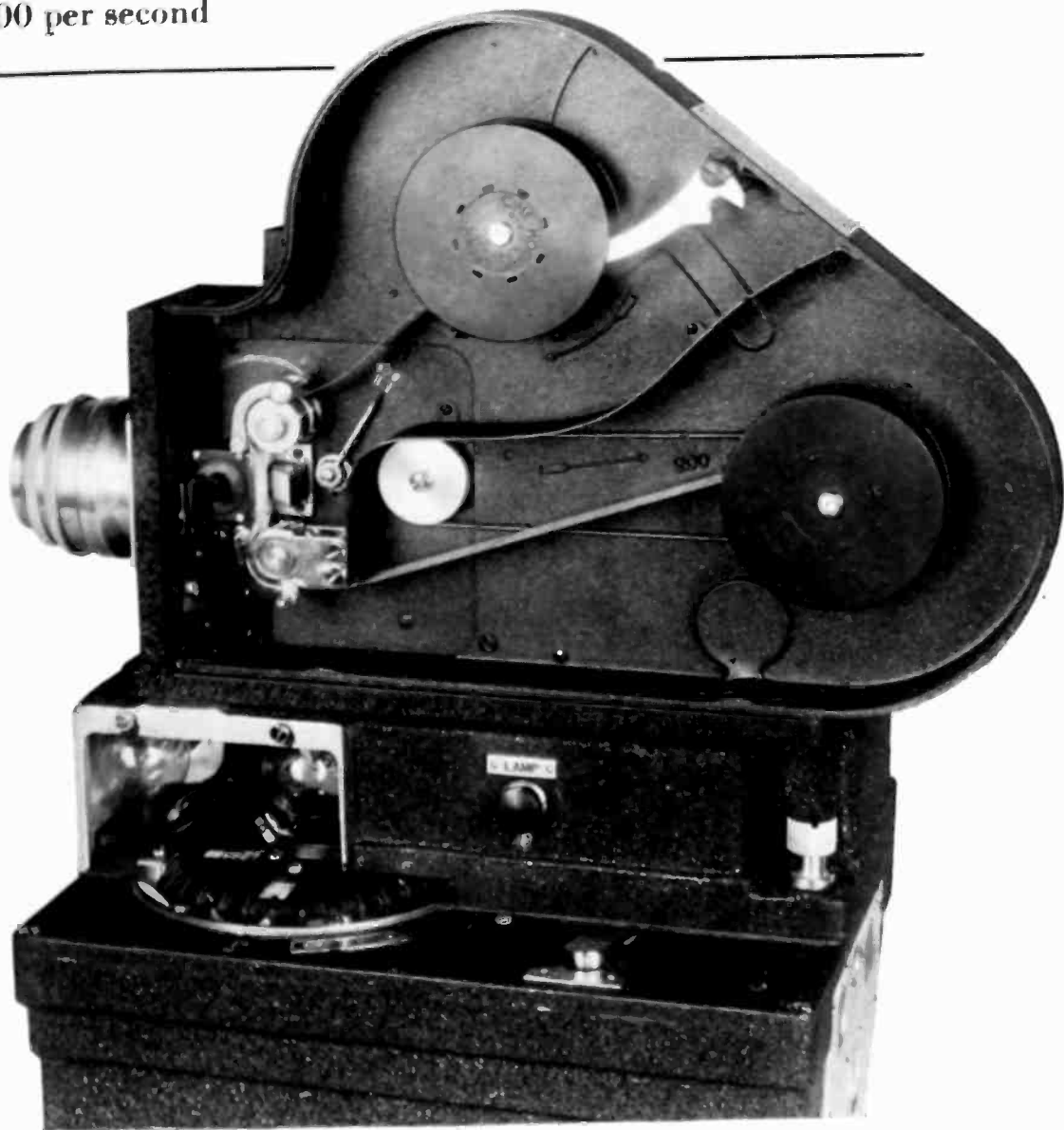

The camera with side cover removed. An electronically controlled clock (see dials in base) times the exposures made on a continuously moving film

possible by the mechanical, optical and electrical design described below.

The Camera Mechanism

Pictures taken by the ordinary motion picture camera are exposed by the so-called "intermittent motion." In cameras of this type the film remains stationary while each individual picture is being taken and is moved to a new position when the shutter is closed. The film is therefore subjected to a number of jerks and twitches which become increasingly hard both on the film and on the mechanism as higher speeds

are attempted. The upper limit of the so-called slow-motion pictures taken by such a camera is approximately 200 pictures per second. The slow-motion pictures shown in theatres are of this type.

When it is necessary to realize picture speeds of several thousand per second, an intermittent action camera is entirely impractical if not downright impossible to build. In the Ultra-speed Camera the film does not stop at each exposure, but moves continuously, thus removing the strain on the film stock and mechanism, and permitting almost any speed within reason to be obtained. To

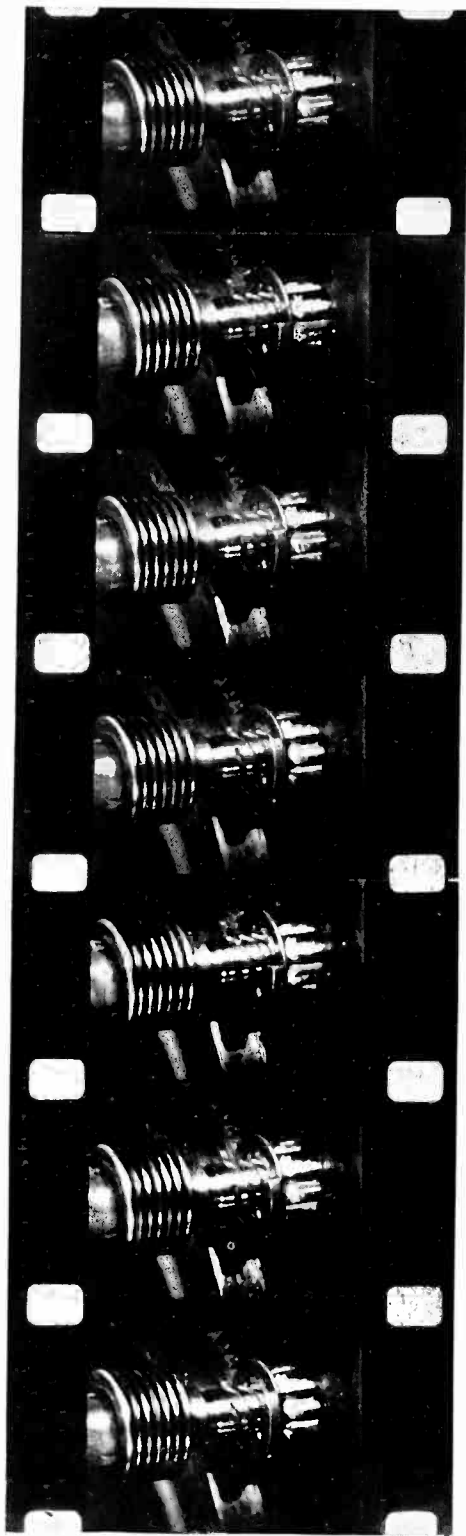

◀ *Left, exposures of a Bendix self-starting drive which revealed that excessive wear was caused by a bouncing pinion (at right of each frame)*

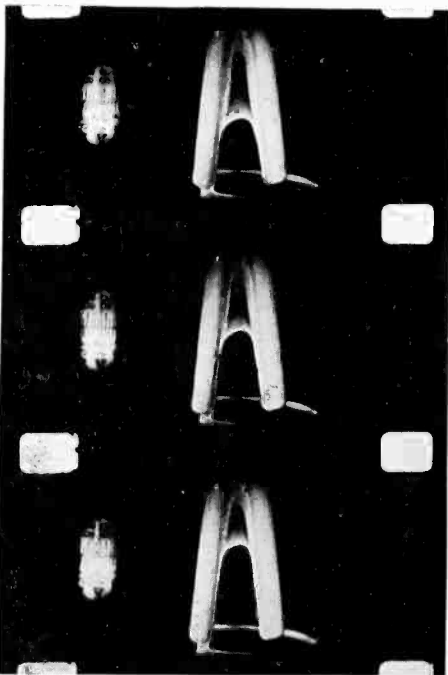

◀ *Latex (raw rubber) film on a test fork. Note timing dials at left which revealed the rate of decay of the film*

expose the film without blurring while it is moving past the shutter a revolving optical translator moves the image with the film. Since there are no reciprocating parts the upper limit of speed in the mechanism is concerned with centrifugal forces and with the physical strength of the film. The upper limit of film speed at present obtainable is approximately 50 miles per hour, that is, about 75 feet per second. By using 16 millimeter film (because it contains more exposures per foot than standard film) the number of exposures per second is still further increased. In addition the 16 millimeter film is convenient because of the wide availability of projection machines for film of this size.

The illustrations show the camera itself and the interior of the mechanism with the cover removed. Daylight loading reversal film is generally used and the same stock is used for projection after development. Below the optical system, at the base of the camera as shown, are the timing dials which are illuminated by the incandescent lamps immediately above them. A lens and prism arrangement throws an image of these dials on the edge of film at the same time that the exposure is made through the lens proper at the front of the camera. Therefore, both the object picture and the clock image are exposed simultaneously on the same film frame.

The Optical System

The optical system through which the picture image follows the moving film at the same speed during the exposure is shown schematically in Fig. 1. A shaft carries the revolving optical translator or plate. This plate receives the image through the lens system and, by the refraction shown in the diagram, shifts the image as the shaft revolves. For each revolution of the shaft the light is admitted for about 25 per cent of the time, i.e., the exposure period is 25 per cent of the time during which

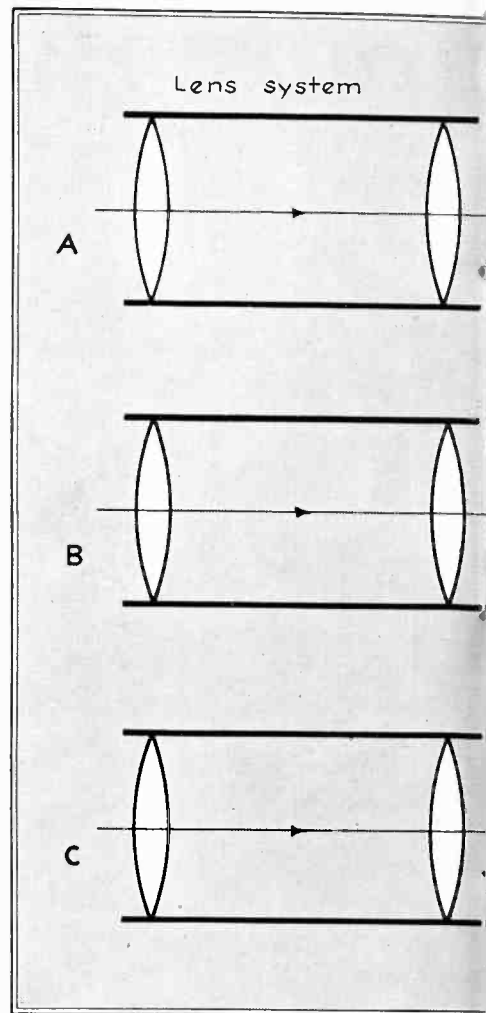

the frame is moving past the optical system. Therefore, when taking pictures at 2,500 per second rate, the exposure is 1/10,000 of a second per picture.

This extremely short exposure time imposes severe requirements both of film sensitivity and of illumination of the subject. Hence, whenever possible it is desirable to run the camera at slower speeds than the maximum. Since the camera speed is under the control of the operator, it may be regulated to suit the requirements of the particular job. The whole camera equipment is operated from 60-cycle, 110-volt current, with a line drain of about 20 amperes.

The timing mechanism is the electronic feature of the camera. To maintain accurate timing to 1/1000th per second, a temperature controlled tuning fork having a frequency of 200 cycles per second is used to induce a voltage in two small coils surrounding the tuning fork arm. This voltage is amplified through a voltage amplifier feeding a power stage which contains two type 50 tubes. The output of this stage is supplied directly to a synchronous a-c motor mounted in the

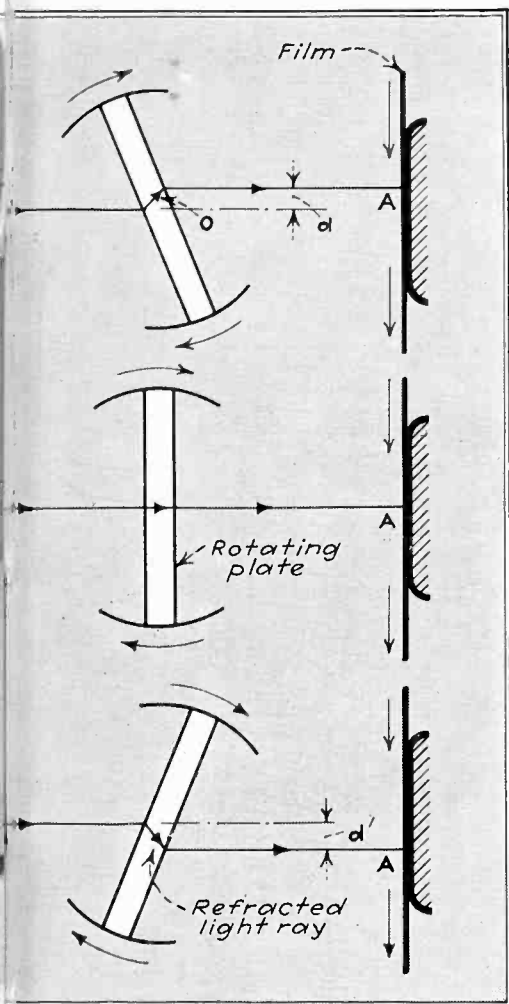

◀ Fig. 1. (left) Optical system which causes the photographic image to follow the moving film. In A, the image point is refracted by the transparent revolving plate so that it lies above the center line. At B, the image has moved down a distance d . At C, as the plate revolves still further, the image has moved downward to d' . During this time the film has moved downward $d + d'$ units, and hence the image remains stationary relative to the film during the exposure

while the position of the image on the film shows the motion which has occurred during that time interval.

Fields of Application

The camera has been applied to a wide variety of industrial problems by the Audio Productions, Inc., of New York City, to whom *Electronics* is indebted for the information presented. The subjects which may be scrutinized by the high speed methods are so various that any general classification of them is impossible, but in general it may be said that information for research and development work is the most fruitful use to which the camera has been put. Occasionally, of course, pictures have been taken for advertising and propaganda purposes. Research engagements made with a camera are, of course, on a confidential basis, but a partial list of projects already undertaken involves the following fields: Shoe machinery, spinning machinery, knitting machinery, sewing machines, firearms, watches, sports products, metallurgy, railroad devices, electric lamps and devices, calculating machines, typewriters, diesel engines, packaging and forming machinery, automotive parts, printing machinery and products, rubber goods and asbestos products. In general it may be said that wherever motion plays an important part in an industrial process, and if the motion is sufficiently rapid to make visual inspection impossible, then high speed motion picture photography may be used with great success. The technique of operating the camera is not markedly different from that used in other types of motion picture photography. Although

base of the camera itself. The timing dials are geared to this motor and thus rotate at synchronous speed. The accuracy of the timing is dependent entirely upon the accuracy of the tuning fork control: for practical purposes 1/1000th of a second is entirely sufficient, although greater accuracies may be obtained without great difficulty.

Film exposed in the camera is developed and reversed by the usual processing. After reversing it is ready for viewing, which may be done in one of two ways. The most striking is to view the film in an ordinary 16-millimeter movie projector machine. When so shown the apparent speed of motion on the screen is reduced by the ratio of the taking speed to the projecting speed which may be of the order of 100 to 200 times depending upon the taking speed. The other method of viewing the film makes use of a magnifying glass under which each frame of the film is examined separately. This method is specially useful whenever it is necessary to analyze the motion presented by the film in any detail. The picture of the timing dial shows the actual time between exposures,

▶ Exposures taken at 1200 per second, of a carbon arc operating on 60-cycle current. One-half of a cycle is shown



The camera "on location." Very large and powerful light sources are required for high speed work since exposures may be shorter than 1/10,000 of a second



there are more items to keep track of than in the case of ordinary photography, results may be as surely predicted and, barring error in manipulation, run as uniform as in any other branch of the photographic art.

Procedure in the Field

In making measurements in the field of scientific research, it is usually wise to make a preliminary survey of the problem before transporting the camera to the scene. This survey will reveal the character of electric current available and location of outlets, the amount of space available, the type and amount of illumination permissible, the colors and contrasts which will be encountered. Knowing the field size, the desired camera speed and the general color value of the subject, a rough estimate of the illumination requirements can be made. In de-

termining the speed required for a given problem, only experience can be used as a guide; the suitable rate for a particular job may depend on the rate of the motion of the object, its distance from the camera, the desired viewing speed on the screen, and the effect of heat (from illumination) on the subject. It should be remembered that although normal exposure presents the best pictures from a photographic point of view it is possible to get fairly satisfactory results for scientific purposes with only 25 per cent of the normal exposure time. The direct reciprocity law seems to apply to the very short exposure used in this work closely enough for all practical purposes, that is, as the exposure time decreases, the illumination must be increased in direct ratio. All of these factors must be considered in determining the film speed. In addition the length of film required for the job must be decided. For in-

stance, when taking pictures at 2,500 per second, a 50-ft. piece of film passes through the camera in less than a second. If 200-ft. rolls are used, a 4-second exposure may be obtained at this speed, but the weight of the rolls means that a certain amount of film must be run through the camera before full film speed is attained. Thus it can be seen that the problem of timing the episode to be photographed with the running of the camera is no small one.

Illumination of the object can be tested with the usual type of photoelectric exposure meter. When the camera speed, stop opening, object illumination, film length and timing all are determined, the exposure may be made.

The Use of the Timing Clock

The clock dials of the camera may be depended upon to rotate with extreme accuracy entirely independent of the camera action. They may be started and stopped by a magnetic clutch under a push-button control, or connected by wires to other controlling agencies. For timing racing events the timing mechanism is started from zero reading by the firing of the starting gun. For research work the starting circuit may be of any convenient type, such as a mechanically operated switch or electronic timing control. The clock mechanism may be stopped in the same manner as it is started.

One instance for which the camera has been used is the photographing of the motion of an airplane propeller, to determine whether undesirable types of vibration are introduced at various speeds. The camera is set up in front of the propeller on its axial line, and an identifying mark is placed on one blade of the propeller. The propeller is then brought up to speed while the camera is taking the picture. Upon examination of the resulting film, the position of the propeller in each frame may be compared with the time indicated on that frame and a graphical plot of propeller motion versus time made therefrom. Vibrations indicated by this plot can be studied at length and when measures are taken to correct the unwanted vibration the success of the correction may be checked by another high speed exposure similarly treated.



Harold Wheeler, Hazeltine

J. A. Comstock, Acme

E. T. Dickey, RCA Victor

Dave Grimes, Philco

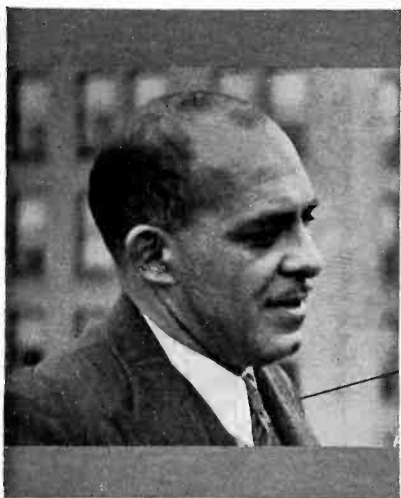

H. M. Lewis, Hazeltine

I.R.E. Fall Meeting



A. A. Leonard, RCA Victor

Radio set and tube engineers discuss new technical trends, hear Armstrong and Zworykin disclose recent work, attack problems of home and auto receiver design

ENGINEERS to the number of approximately 350 (plus those who did not register) attended the Rochester Fall meeting of the Institute at Rochester, argued over the merits of frequency modulation, learned about the problems of making metal tubes, about the quality of various component parts entering into receiver construction and how to measure this quality, learned of recent research leading to better superheterodyne oscillator design, and other subjects. The following summary of the papers written by the Editors of *Electronics* at Rochester is presented as a record of this annual convention and for the information of those unable to attend. Photographs of those in attendance were made by Leslie F. Woods of Philco and by the Editors.

It is worth noting how frequently the question of noise appeared in the discussions at the Convention. The most noteworthy feature of the Zworykin and Armstrong developments as described by them is noise reduction. The Barden-Seeley paper quoted below dealt entirely with circuit and tube noise. The Timmings paper dealt with the influence of circuit constants on noise.

The following notes are taken from the paper of W. S. Barden and S. W. Seeley of the RCA License Division. By using the well-known formula for thermal agitation noise, the authors state that in a tuned secondary of $LCR = 100,000$ ohms loosely coupled to an antenna, so that only the secondary resistance contributes to the noise, N_R is approximately 4 microvolts across grid-

cathode. Then assuming that the coupling is so adjusted that the transfer from antenna to grid is $\frac{1}{2}$, it is seen that the antenna signal voltage must be at least 16 microvolts to be equal to the noise. During periods of low modulation, such a signal would not be satisfactory. Since $R = 1/Q\omega C$, the noise is proportional to $1/\sqrt{\omega}$, and the thermal agitation noise is most annoying at the longer wavelengths. Curves were given to show the relation between Q and noise.

By a special measuring arrangement, Barden and Seeley determined the value of noise N_g contributed by the tube itself, as though a noise generator were in series with the internal plate resistance. They recommend that this characteristic is a basic tube property which might well

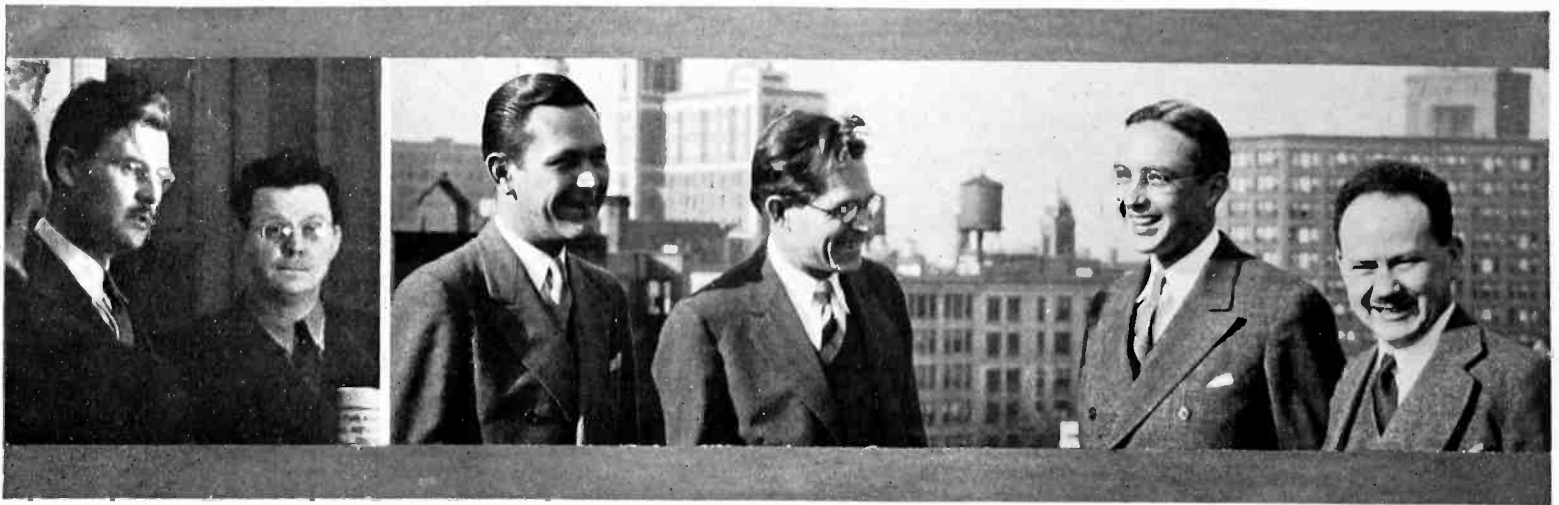

Kelly Johnson, Wells Gardner
Ray Zender, Lenz Electric

Lloyd Hammarlund,
Hammarlund

George Crom,
Colonial

R. M. Purinton,
Raytheon

B. E. Shackelford,
RCA Radiotron

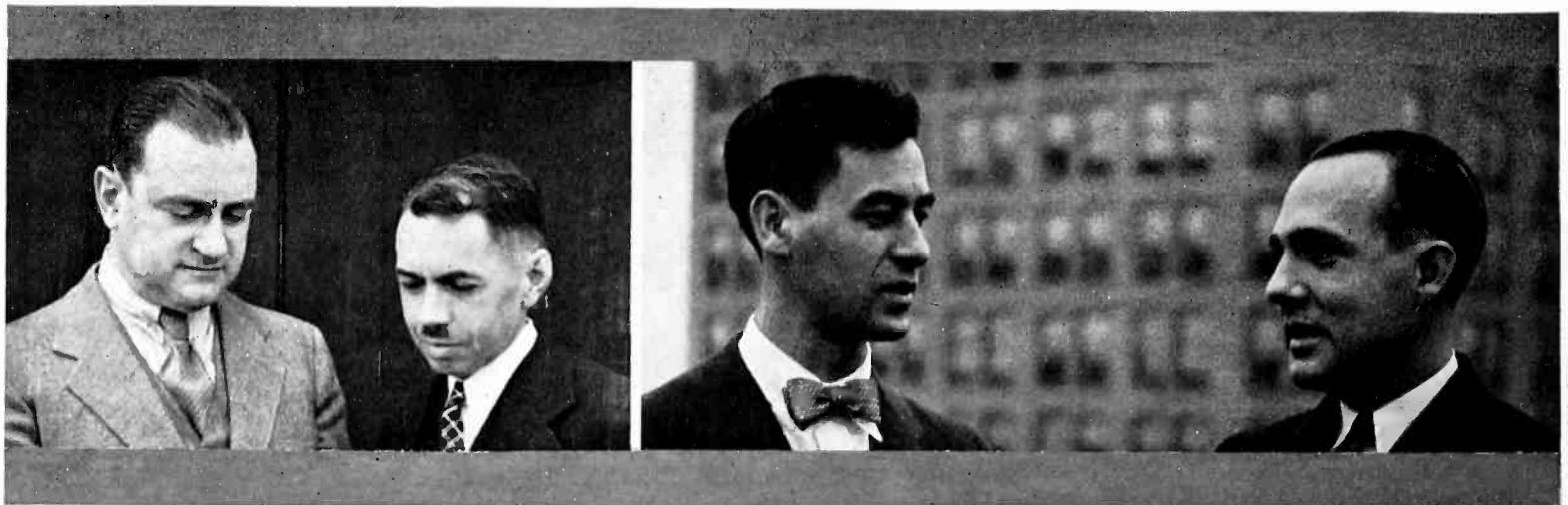

Dr. A. N. Goldsmith

L. F. Curtis, Bosch

Harold Westman, IRE

F. X. Rettenmeyer, RCA Victor

be given by the tube manufacturer along with the other tube data. This value is independent of the load.

In modern r-f pentodes this value is of the order of one microvolt for bandwidths used today. For converter tubes (6L7, 6A8, etc.) it is equal to 4 microvolts. Other conclusions are that increasing Q in a pre-selector-tuned secondary is only of moderate value if the coupling to the antenna is close enough to provide good step-up. Finally, Barden and Seeley feel that the wide discrepancy existing between predicted and measured shot noise in pentodes may be due to the division of space current between screen and plate.

C. J. Franks Discusses Quality

Coils, condensers, resistors, dielectrics, chokes and tube input losses all came under discussion in the Franks paper giving the development of the Boonton Q meter (for a photograph of this device see *Electronics*, August, 1935, page 249).

Two general methods of measuring Q , the ratio of reactance to resistance of the device under study, were described, the reactance variation method and the amplitude variation method. In final design the Q meter measures the ratio of the resonant voltage across the unit being studied to the voltage impressed on the circuit. If this voltage is maintained constant, the voltage across the unit under measurement can be made to indicate directly the Q of the unit. Illustrations presented by the author of values of Q for various types of components were given in Mr. Franks' paper.

Metal Tube Problems

Roger Wise of Hygrade Sylvania discussed the problems incident to manufacture of metal tubes and indicated that production on these newer types of tube was rapidly approaching the point where any orders in quantity could be filled with the certainty that tubes would be

satisfactory in service. He described the work that went into the development of the new diode-triode which holds, in the metal tube series, the approximate position of the 75 in the glass series.

Some trouble has been had with high frequency losses due to the insulation used in the top to protect the grid. Mr. Wise stated that special ceramics had been used where necessary which seemed to eliminate this sort of trouble. There was some discussion of the difficulties incident to proper cleaning of the parts going into the tubes, especially with reference to schedules of hydrogen firing. The question of whether to use the parts immediately after hydrogen firing, or whether to allow them to stand in hydrogen or dry air after firing for a certain period of time was discussed to a considerable extent. Apparently these matters of manufacturing procedure are not yet as thoroughly settled, as is true of the glass tube art.

"A Tragedy in Specifications," by

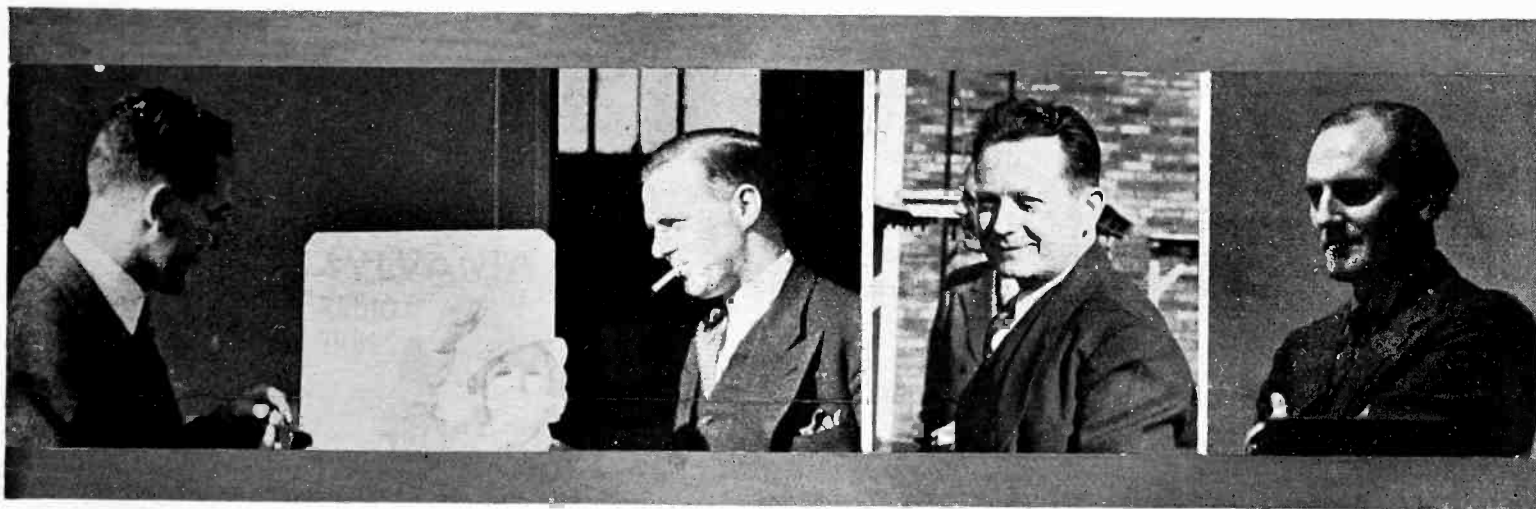

*Virgil Graham,
Sylvania*

*Ted Wilby,
RCA Labs*

*Ken Henderson,
Stromberg*

*A. L. Williams,
Brush*

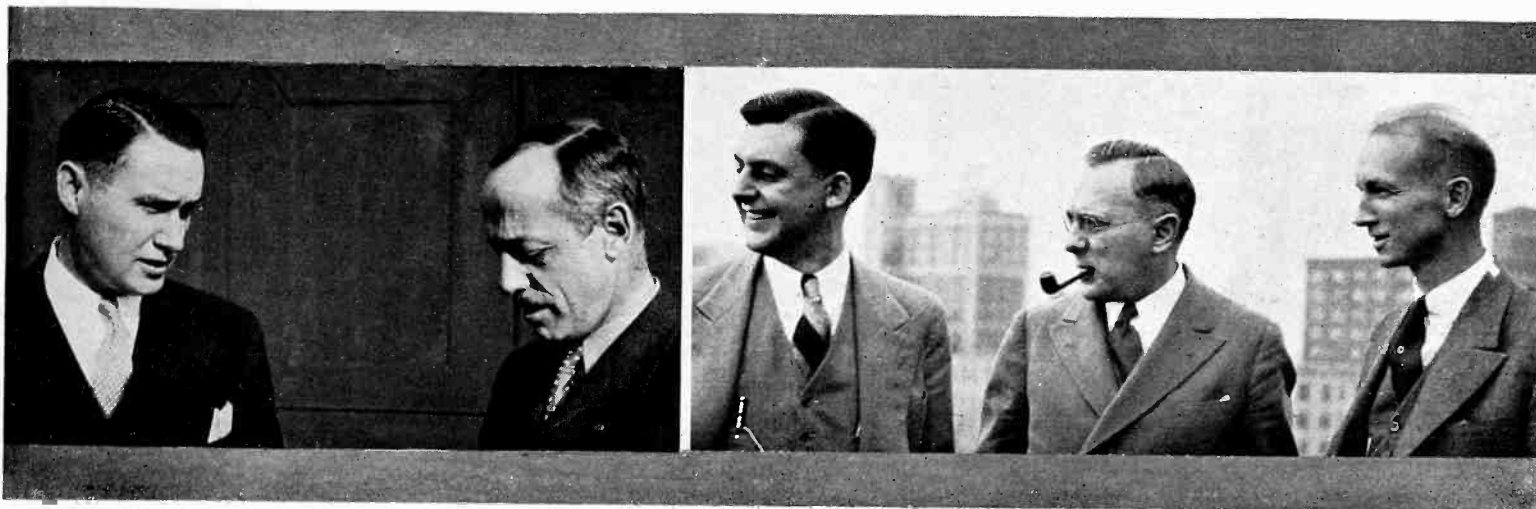

*Gene Ritter,
RCA Radiotron*

*George Lewis
I.T.&T.*

*John H. Miller,
Weston*

C. W. Horn, NBC

*H. L. Olesen,
Weston*

L. C. F. Horle, and "Management's Stake in Standards," by P. G. Andrew, of the American Standards Association, presented a subject of vital importance to the radio industry.

In the search for low-priced parts, the set manufacturers themselves seem completely unwilling to practice the use of standardized parts which, as well demonstrated in other industries, is a most potent force leading to reduced costs. Mr. Horle surveyed parts manufacturers, learned the vast number of nearly-identical units which suppliers were called upon to produce and presented a very sorry picture. The advantages in standardization of parts most often used were pointed out by Mr. Andrew's paper which gave the results of such industry effort as discovered in the manufacture of automobiles and other mass-production items.

Noise as a limiting factor in amplifier design entered into the paper read by George H. Timmings

of the Meissner Manufacturing Company, makers of air and iron cored radio-frequency and intermediate-frequency inductances. Particular reference was made to automobile antenna input systems where a high signal-to-noise ratio is desired owing to the low pickup ability of the average automobile antenna. The effect of Q on this ratio as well as on the resonant voltage built up in input secondary circuits, the rôle of the coupling between primary and secondary in high and low impedance input systems, and the virtues of the condenser input systems were discussed.

The advantage of iron-cored coils were disclosed to be the higher Q obtainable and the gain in space because of the higher permeability possible. Mr. Timmings pointed out that anything done to improve the Q of the secondary circuit in the input transformer would improve the signal-to-noise ratio provided that the coupling to the primary were maintained fixed. On the other

hand if the coupling is varied to get constant voltage gain, increasing the Q of the secondary decreases the signal-to-noise ratio.

In a description of apparatus employing cathode ray tubes, O. H. Schade of RCA Radiotron showed methods for making visible instantaneous traces of tube characteristics. A demonstration was given of the equipment showing how the apparatus showed the laboratorician the effects of various factors in changing tube characteristics of both the static and dynamic types.

The Electron Microscope

A striking demonstration of the electron microscope, one of the newest research tools, was made by W. H. Kohl of the Rogers Radio Tubes Company, Ltd., of Canada. It was pointed out that streams of rapidly moving electrons, such as are present in the usual cathode ray tube, have properties very similar to light waves, in that they can be refracted

by electric or magnetic potentials in the same way that light is refracted by a lens. The various types of electron lenses, electrostatic and magnetic, were described, and their use demonstrated in several typical tubes. Mr. Kohl has agreed to write a paper for *Electronics* on this interesting subject, which will appear in the near future.

Wheeler Confirms Armstrong's Results

In the discussion at the conclusion of Major Armstrong's paper on frequency modulation (essentially the same as the paper presented before the New York Section and reported in the November issue of *Electronics*), Harold A. Wheeler of the Hazeltine Service Corporation presented a mathematical confirmation of the experimental results obtained. The gist of Mr. Wheeler's argument, in non-mathematical terms, is as follows:

The Armstrong frequency-modulation receiver is essentially a measurer of the intercepts of the incoming wave along the time axis, rather than a measurer of the envelope of the wave, as is the case with amplitude modulation systems. By the use of a current limiter, the envelope variations are removed, while preserving the intercept distances which contain the intelligence.

The improvement in signal-to-noise ratio is explained by Mr. Wheeler in terms of the efficiency with which the bandwidth is used. In amplitude modulation, only the higher frequencies make efficient use of the available band-width, since the low frequencies occupy only a small

space in the band. The noise comes from the whole band.

In frequency modulation, the band is used with equal efficiency by both high and low frequencies, hence the low frequencies experience an improvement with respect to the noise. This improvement is obtained even if the band-width is no wider than that used in the corresponding amplitude modulation.

When an extended band-width is used, as in the Armstrong experiments, the whole extended band is used efficiently by the signal components of high or low frequency. The noise, on the other hand, comes from a very narrow band (within an audible limit of the carrier); the noise is thus making inefficient use of the total available band-width, and as a result the signal (both high and low frequencies) is proportionately stronger than the noise.

Calculations made by Mr. Wheeler of the improvement, under the conditions used by Major Armstrong, reveal a possible 31 db gain in the signal with respect to the noise. This gain is very close to that actually measured in the experimental set-up.

Superheterodyne Oscillator Design

The perennial problem of "how many turns to put on the tickler coil in a superheterodyne oscillator" was discussed fully by W. A. Harris and R. H. Siemens of the Radiotron Division of RCA Manufacturing Company. Mr. Harris, who delivered the paper, considered the tuned-grid circuit since it is used in the majority of receivers. He covered two frequency ranges, 6 to 20 Mc and 20 to

70 Mc. Because Mr. Harris's paper is in printed form and is readily available it will not be reviewed here further.

Zworykin-Armstrong offer repeat performances

V. K. Zworykin and Major E. H. Armstrong described their recent work as disclosed at the October and November I.R.E. meetings and as published in November *Electronics*. Dr. C. B. Jolliffe, speaking as Chief Engineer of the Federal Communications Commission, related the efforts in the past toward proper allocation of frequencies in the spectrum and gave a good account of the difficulties of knowing exactly what to do with the higher frequencies now assigned on an experimental basis only. The care with which such matters are handled by the FCC was brought out with considerable emphasis by Dr. Jolliffe whose charts showed graphically the rate at which new portions of the spectrum are being utilized.

L. M. Clement of the Victor Division of RCA presented a paper, through F. X. Rettenmeyer, disclosing the differences in European practice of making radio sets compared to those in vogue in America. Prices, wages, costs and other variables having an intimate rôle to play in the set-making industry were brought out.

Several of the papers presented at the Rochester Convention will be published in the Proceedings of the I.R.E. and it is hoped that several of the others will be reported at greater length in *Electronics* by the authors themselves. These will appear in near issues.



W. A. Harris, RCA Radiotron C. J. Franks, Boonton Radio Howard Rhodes, Aerovox Leslie Woods, Philco

Electronics in Oil

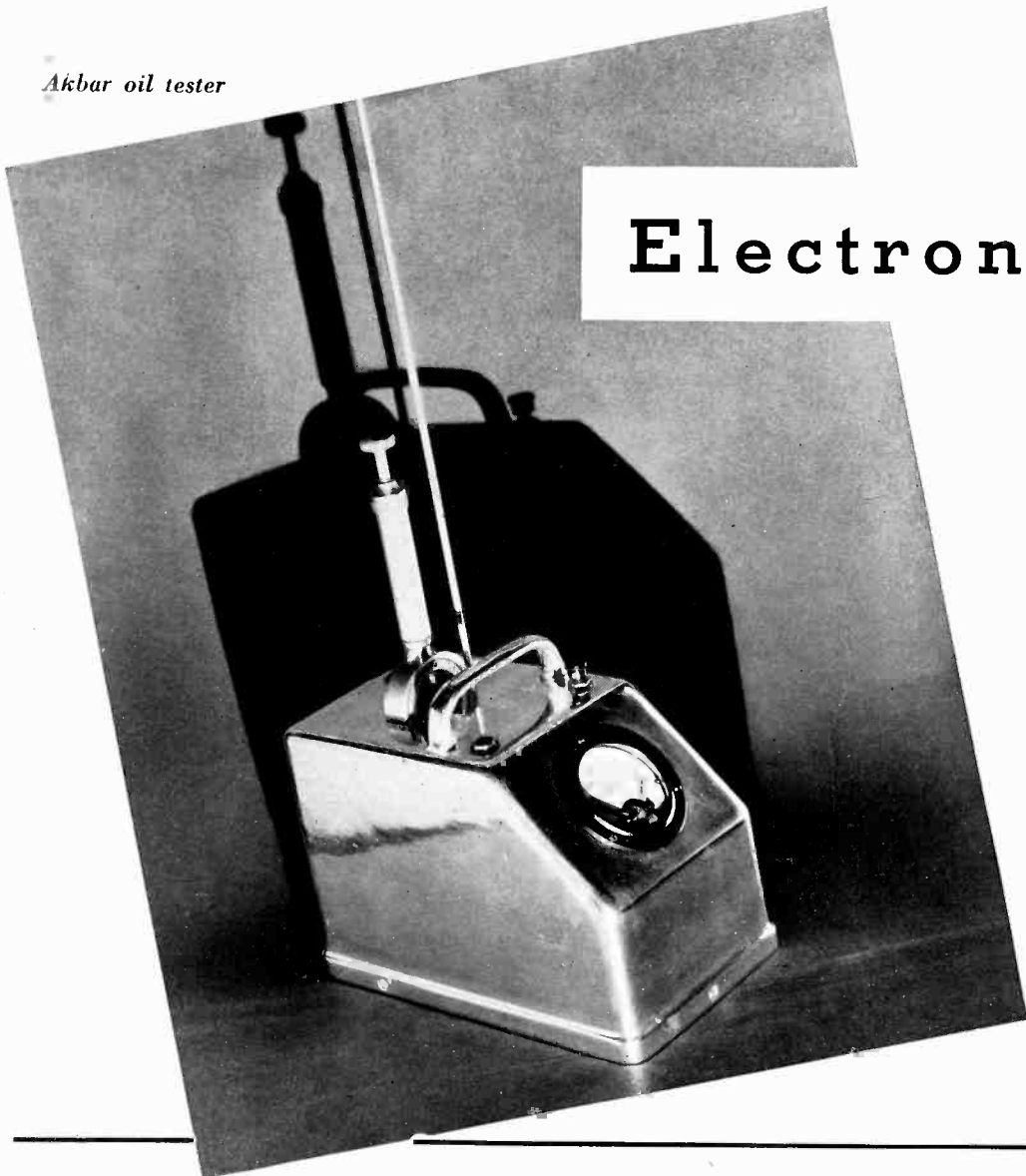

Useful and dramatic applications of electron tubes to finding, refining, using oil, and measuring its quality

THROUGHOUT all industry, electron tubes are proving that the smallest particles of the universe can be the most useful.

The following uses for electron tubes in the oil refining industry have been uncovered by correspondence with subscribers to *Electronics* who are identified with the oil business. Undoubtedly there are other unreported uses for amplifiers, phototubes, or other types of tube; perhaps this brief summary will not only stimulate activity among other oil men, but may induce them to describe their work through these pages.

Such an application of the phototube is that of testing oil that has been used in automobiles. The device known as the Akbar Oil Tester

(Akbar Company, 2921 Chapman Street, Oakland, California) utilizes a light-sensitive cell to indicate the lubricating quality of crank case oils. The device is for use by garage and service station attendants.

Oil in a crank case is subject to many sources of contamination, such as carbon, metallic particles, road grit and sludges from the breakdown of the oil itself. When this contamination reaches a certain point the oil should be drained and replaced. In the Akbar unit a sample of the oil is placed between two color filters located a certain distance apart. A source of light illuminates this uniform section of oil and the amount of light that penetrates to reach the light-sensitive surface is read on a meter.

The device is said to eliminate the methods of estimating the proper replacement time (500 miles according to oil advertisers) such as mileage, rubbing between the fingers, etc. Oil that becomes contaminated early in its life after being placed in a crank case indicates one of the following troubles:

1. Sludge remaining in crank case contaminating the new oil. This can be remedied by flushing at next oil change with a flushing oil.
2. Filter not properly functioning.
3. Water in the crank case.
4. Worn piston rings.
5. Improper grade of oil.
6. First filling of crank case after overhaul.
7. Poor road conditions or low gear driving.

Allied to prospecting, in that the device reveals what is beneath the surface of the ground, is a most interesting application of the light-sensitive cell made by the Dale Service Corporation, 6765 Romaine Street, Los Angeles.

The problem of locating the source, or point of entrance, of formation water in oil wells is of vital importance to production men, numerous methods of locating water having been devised in recent years, virtually all of them depending on the varying degree of electric conductivity of well fluids. Practical oil men are familiar with the general procedure, including the repeated conditioning of the well with fresh water, chemicals, or, under certain circumstances, salt water, in an effort to establish a standard solution of known electrical conductivity differing from that of the entering water.

The Dale device seems to be a simple method of solving a difficult problem. According to the Dale Corporation it readily determines with a fine degree of accuracy the point or points of entrance of formation

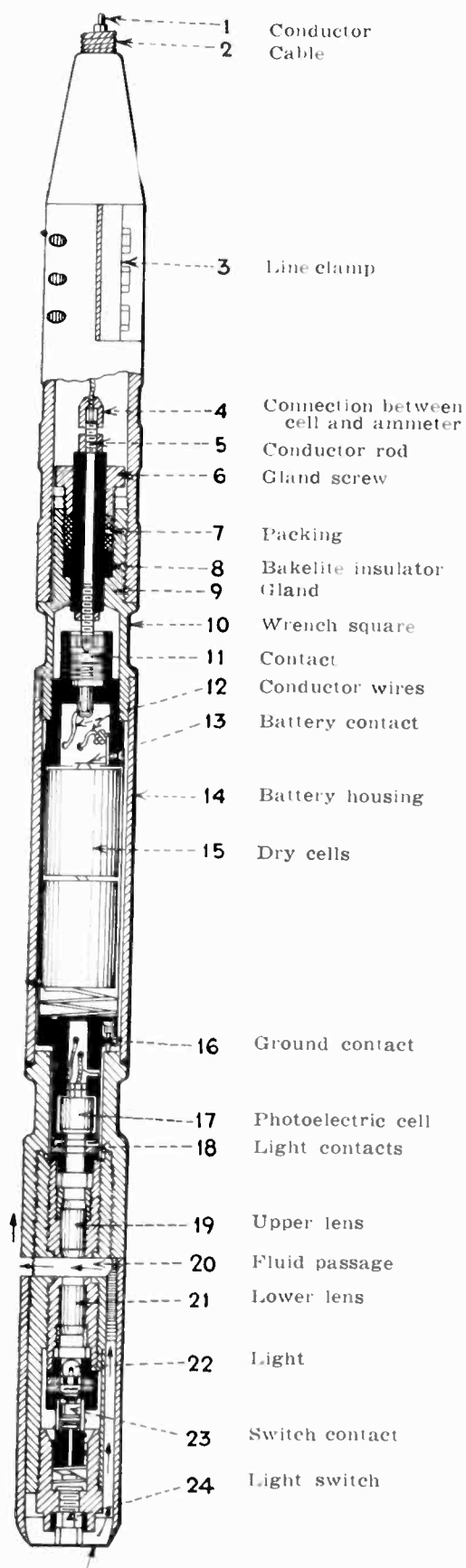

Phototube water detector

water, whether saline or fresh, without the use of chemicals. It is based upon the fact that formation water entering an oil well is clear, since the solid materials have been filtered out as the water passes through the sands.

The device itself consists (in electronic language) of a self-generating cell which is let down into the

well together with a source of light. Liquid is passed between the light and the cell so that any changes in the translucency of the liquid makes itself known in a change in the output current of the cell as read on a microammeter at the top of the well.

When conditioning a non-flowing well preparatory to running a test, the hole (in oil language) is spot conditioned by dumping mud or dye with a bailer or circulated rotary mud weighing about 64 pounds per cubic foot. Such material forms a good contrast with the clear formation water entering the well.

From the photocell in the device an insulated wire in the center of a steel cable leads to the current meter at the ground level. Sliding contacts are made with the cable as it leaves the hole and at the same time a measuring device attached to the cable makes a record of the depth of the instrument in the well. An operator can thereby make a graph of the readings of the microammeter plotted against the depth of the instrument.

Color is Important

A rather obvious use of phototubes is in testing the color of materials entering into the refining process. For example one engineer states that his company has used vacuum-type phototubes for recording the color of side streams (oil language, again!) overhead and circulating oil leaving fractionating towers; that he has heard that another company has used copper-oxide cells of Westinghouse in the determination of lub oil colors in a process that is more accurate than is possible with Universal or Robinson equipment.

Phototubes and other electron tubes (see *Electronics* June 1934) are well known for their use in maintaining temperature, an important factor in various processes of oil refining. Another engineer states that his company has purchased a number of light-sensitive cell units to determine intensity of display lighting effects in a study of roadside gas and oil service stations.

It is also stated by this engineer that the phototube recording of circulating oil and overhead streams in fractionating towers would be profitable in determining whether or not the tower was upset. He be-

lieves that color comparators would end many arguments which occur when lub oils must meet certain color specifications—they would eliminate the human error in such matters.

Still another oil engineer, reader of *Electronics*, states that temperature control is of considerable importance in the DeFlores system of cracking oils in the vapor phase. Here minute control of the temperature of the preheating furnace is essential for efficient operation. He states, "the oil industry offers an enormous field for the further application of the electron tube. The testing of oils is very important in the refining process and this testing offers many tube possibilities. Color of distillates, hydrogen-ion concentration, carbon content are only a few of the possible uses for tubes."

Pipe-line Finders

In the pipe line industry the vacuum tube is used very effectively to locate buried pipe lines for the purpose of reconditioning or the removal of old lines, which are to be taken up and abandoned. In the case of pipe that has been buried 12 or 15 years it often happens that normal erosion has increased the depth of soil over the pipe line from 2 feet to sometimes 10 feet to 15 feet and should a leak occur in that vicinity and saturate the soil with oil over a large area it would often require considerable hand ditching to locate the pipe if only the original maps had to be used for reference as to the exact location of the buried pipe.

It has been known to take as much as a week or ten days hand ditching to find the pipe in such locations, before the advent of the "pipe-line finder," because it was not anticipated that the pipe could be buried at such a depth.

With the advent of radio tubes it has been possible to devise what is known as a "pipe-line finder." The transmitter consists simply of a Western Electric No. 5 Induction coil with vibrator, two No. 6 dry cells and two cords for the purpose of placing the ground rod at a distance of approximately 120 feet at right angles to pipe line. This causes harmonic waves to circulate from the contact on the pipe, through the pipe and earth back to the ground rod from the spark type transmitter.

The pipe line is then located by the use of an antenna wrapped on an eighteen-inch bicycle rim, a small amplifier and a set of head phones. The operator walks down the pipe line guided by the tone heard in the head phones from the antenna, which is moved slowly from side to side of the pipe line, the strongest tone being always directly above the pipe line. At stated intervals stakes are driven for the use of the ditching gang which may follow the preliminary survey.

The character of the soil and the condition of the pipe or coating create the most variables governing the distances to be used between transmitter settings. On good coated pipe the transmitter can be heard over a distance of 7000 feet to 8000 feet and on bare pipe the maximum is about 1300 feet. Also, wet ground, clay or salt marshes present a good return path for the currents and the transmitter can only be heard for approximately $\frac{1}{4}$ mile, whereas dry sand or rocky soils will permit operations over a distance of a mile or more between settings.

Oil Analysis

It has been determined that the end of the useful life of lubricating oil or oil for insulation is accompanied by an increase in power factor. Pure oils have low power factors; increasing impurities increase the power factor. Since the values of power factor are very low, much work has been done toward developing methods of measuring this quantity. The General Radio Company, for example, is manufacturing "cells" for the measurement of dielectric constant and power factor of oils following the design originated by Professor J. C. Balsbaugh of Massachusetts Institute of Technology.

Here the measuring electrodes are concentric polished-nickel cylinders. The inner cylinder is mounted on a central tubing of pyrex glass through nickel discs. The outer cylinder is supported on two pyrex rods fastened to two guard cylinders, which are mounted on the central tubing in the same manner as the inner cylinder. These mounting discs are punched with holes to allow circulation of the oil being measured and of the cleaning liquid used when the oil is changed.

The leads from the outer and guard cylinders are nickel wires, that from the former being shielded by nickel tubing connected to the guard. A flexible copper lead from the inner cylinder passes inside the central pyrex tubing, which is large enough to contain a thermometer for measuring the temperature of the oil.

The electrode structure is mounted in a pyrex glass container, having a ground joint and two tubulations. The cell may thus be operated in a vacuum or in an atmosphere other than air. Thus, it is a convenient research tool.

The over-all length is 18 inches and width across tubulations, 8 inches. The outside diameter of the glass container is 4 inches.

The direct capacitance of the measuring electrodes is 90 μf with a spacing of .075 inch. The volumetric capacity of the container is 1000 cc.

Cells for the measurement of the power factor and resistivity of oil will vary in their design dependent upon the magnitude of the power factor and resistance to be measured. Cells ranging all the way from simple two-electrode cells, good only for the very roughest of measurements, to three-electrode cells with a guard ring so arranged that the insulating material is not in contact with the oil were discussed at the recent meeting of the A.S.T.M. held in New York the week of November 4.

At this meeting the main subject of discussion in the various subcommittees of Committees D-9 on Electrical Insulating Materials was the measurement of resistivity, dielectric constant, and power factor in oils and other insulating materials. There was considerable discussion on the design of oil cells and the necessary accuracy of measurement.

In general the oil manufacturers were more interested in high precision than the consumers. Part of this difference of opinion comes from the fact that the large oil companies have established research laboratories in which accurate measurements can be made and have men who are capable of making them. On the other hand, the cable manufacturers are interested in the actual performance of the cable in use under operating conditions. The vari-

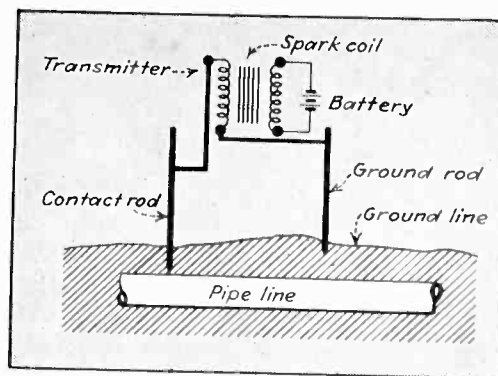

Transmitter for locating buried pipes. Receiver is a detector, two-stage amplifier, loop and phones

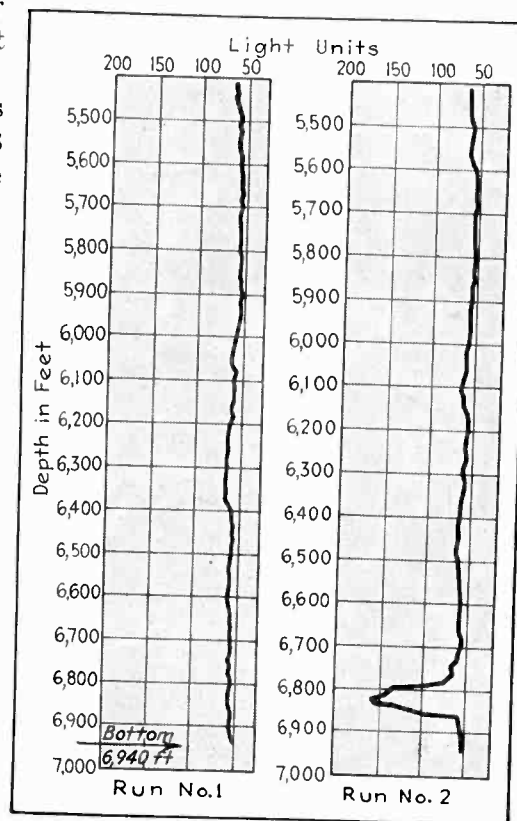

Two runs, before and after permitting fresh water to enter hole at 6810 to 6820 foot level

ous operating power companies seem to occupy a middle position dependent upon the size and excellence of their research laboratories.

The possibility of the great divergence between these groups is due to the fact that the very best cable oil has at a temperature of 20 degrees Centigrade a power factor as low as 0.00001, while the same oil at the operating temperature of 100 degrees Centigrade has a power factor of 0.005. There is a similar change in resistivity of the oil from 10^{15} ohms at room temperature to less than 10^{12} ohms at operating temperature. In addition, there is rapid deterioration of the oil due to oxidation and the accompanying formation of sludge, which increases markedly the power factor even at room temperature.

High gain—simplified

An account of the design of a two-tube microphone amplifier, 25 to 10,000 cycles with 73 db., in which grid-bias cells were used to reduce parts, to eliminate the need of shielding, and to preserve the designer's sanity

IT IS an unfortunate fact that the lower the initial cost of a high quality velocity microphone the less its output level. The quality may be, and often is, just about as good as that of more expensive types, but its output is governed to a great extent by the strength of the magnetic field about the ribbon and it is the magnets which are the major item in the cost chart of a velocity microphone.

The purchaser of a low output microphone must make up this loss by additional gain in the amplifier. Frequently he finds, when he is all through, that it would have cost less to buy a more expensive microphone in the first place. For years microphone manufacturers have faced this problem and have attempted to raise the output of their inexpensive models with the result that the velocity microphones available today far surpass the older models in every

By **PAUL VON KUNITZ**
*Chief Engineer, Radio Division
Bruno Laboratories
New York*

major requirements: It must have high gain, in order to bring up the low input level to a high value. It must have a good high fidelity characteristic in order to do justice to the velocity microphone. It must be extremely low in cost or it would defeat its own purpose. Of course, there is no difficulty in fulfilling the first two requirements if the third is ignored. When the three are considered as a unit a great number of difficulties crop up.

Those experienced in building high gain, low input amplifiers know that perhaps the greatest difficulty encountered is that due to hum picked up from stray fields. By far the worst offender in this respect is the input transformer.

If the input transformer to the amplifier could be rendered unnecessary, so that the device would always be working as a bridging-input amplifier, it would kill three birds with one stone. The cost would go down materially, hum troubles would be tremendously reduced, and quality would not be limited by transformer characteristics. Two other problems would automatically come to the front, however. It would be necessary to increase the gain following the grid of the first tube, in order to get the same results, and in doing this the thermal agitation and shot effect noises would rise to troublesome levels. It was decided to follow this course and eliminate these noises, in so far as possible, by good design.

The Noise Problem

Thermal agitation noises can be kept at a minimum by reducing the resistance of the input circuit to its lowest possible value, by materially reducing the width of the frequency band passed, or by lowering the temperature. Of all these methods the first is the only practical one in this case. If the microphone output is the only device in the input circuit, and if it is of low resistance, experience has proved that thermal agitation will not be bothersome.

Shot effect is usually quite troublesome in high gain amplifiers, producing a rushing sound very much like that of "carbon rush" in a carbon microphone. It was found that it could be held at a satisfactory low level by choice of input tube and by operating this tube at full heater temperature and low plate voltages.

Choice of Tubes

Because a high gain tube was necessary at the input, with the other considerations involved, the choice fell on the 6C6, or the 2.5-volt counterpart, the 57. A further advantage of these tubes is that they are



Close-up view of the grid-bias cell (twice actual size)

respect. It was felt, however, that the amplifier side of the question had never been systematically tackled and it was this view that led to the development of the unit described herein.

The amplifier must fulfill three

It seems the part of common sense to try to eliminate the necessity for this input transformer. A move in this direction is seen in the use of a microphone having a high impedance output meant to work directly into the grid of the first tube.

relatively unmicrophonic. In the amplifier as finally constructed there was found to be no necessity for cushioning of any sort.

To reduce the cost further, it was decided to render the use of an output transformer unnecessary. As it was desired to have a maximum of two tubes, and as the gain must be equal to that of an amplifier using transformers, this imposed a severe set of requirements on the second tube. It had to provide very high gain and yet work into an output load as low as 20,000 ohms, and without harmonic generation. High gain and low plate impedance never go hand in hand, but a solution was found in the use of the 6A6, or the 2.5-volt type, the 53. This tube consists of two triodes in one envelope. Using the first in cascade with the second gives a voltage gain of over 700 with an output load of 20,000 ohms.

This choice of tubes gives a three-stage amplifier, the second and third tubes having common cathodes. Such a combination spells trouble to the experienced designer, due to common coupling, which will cause motor-boating.

The first solution to this problem attempted was to construct the amplifier in such a way that it would not pass frequencies low enough to resonate with the power supply circuit. Such a cut-off can only be obtained by using degeneration in the circuit. By proper choice of bypassing condenser values, degeneration at the low frequencies can be introduced in the grid return, and screen grid return circuits. Advantage of this was taken in the first and third

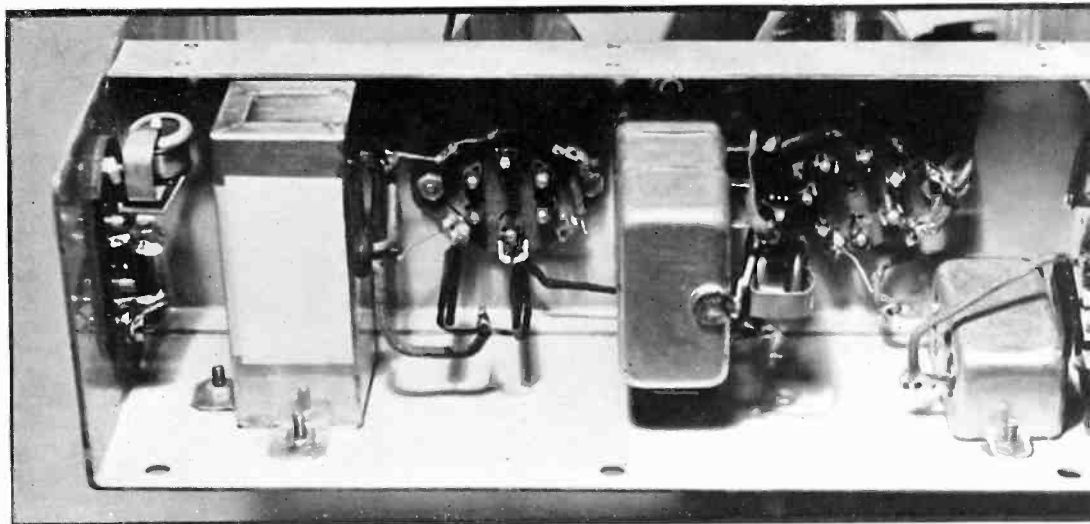

The simplicity of the wiring is shown in this sub-panel view. The large blocks are by-pass condensers

stages. To avoid oscillation due to coupling in the common cathode connection for the last two stages the second stage had to be isolated as completely as possible by means of heavy grid and plate filtering circuits.

The resulting amplifier proved excellently stable when very carefully laid out and when run from a fairly low impedance power source. However, as it was desired to further reduce the cost of the device by making it able to operate from any power supply at hand, even that of the main amplifier associated with it, the results were not those desired.

The next step was to shelve the degeneration idea and supply such adequate filtering that no coupling would be possible.

The results given by this circuit were very satisfactory indeed. The amplifier showed a gain of 73 db and was very quiet and stable in operation. It was found, however, that

the layout and shielding of the last two stages was extremely critical. Even with a large amount of filtering there still seemed to be too much coupling between the last two stages. Further tests proved conclusively that this took place in the common cathode connection.

Use of Grid-bias Cells

The only solution that suggested itself was the use of "C" batteries which would automatically obviate the trouble but introduce that of replacement. This thought led to the use of Mallory electrolytic cells. These cells consist of two metallic plates separated by a hermetically sealed-in electrolyte. They generate a constant voltage as long as no current is drawn. If current is drawn their voltage falls until the drain ceases, when it again rises to normal. If current is delivered to the cell its voltage rises until delivery ceases, then it slowly falls back. They have practically unlimited life, are extremely rugged, and have now been under test for about two years. Furthermore, they are inexpensive.

The amplifier was entirely redesigned to take advantage of the cells, one for each tube, with a considerable lowering of the cost and number of component parts as a result. As all cathodes could now be made to have ground potential the hum from this source was greatly reduced. Also, as all grid and cathode return filter circuits were thrown out, a great saving in cost resulted. With the new arrangement it was possible to keep one input and one output terminal at ground potential, lowering the possibility of stray field pick-up in these circuits.

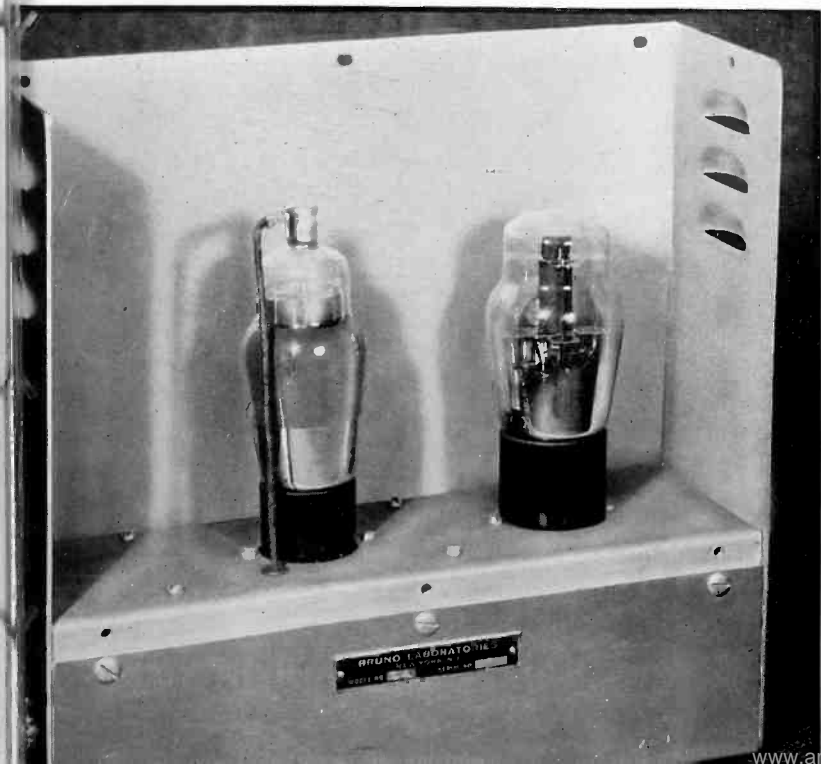

View of the unit with cover removed. The complete absence of inter-stage shielding is a feature of the design

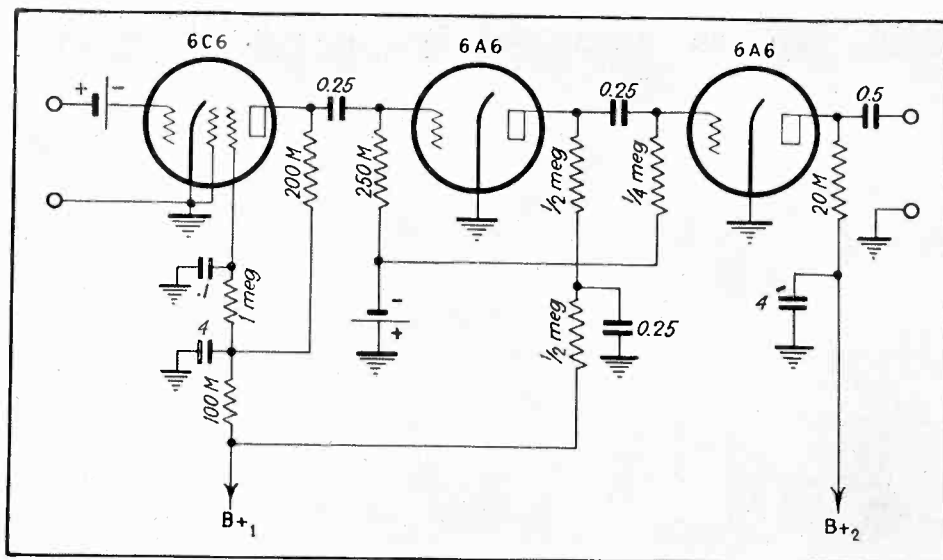

Circuit diagram of the amplifier as it finally evolved. The two tubes marked 6A6 are in the same envelope

As all tendency towards oscillation or motorboating vanished in the new circuit there was no need to employ degeneration at the low frequencies and all internal shielding was dispensed with. An amplifier of this type can be constructed to have a frequency response flat from a few cycles to those above audibility by proper choice of circuit constants. Oscillograph tests show no harmonic distortion below the overload point. The gain measured is 73 db and the output voltage obtainable from the last stage varies from thirty to seventy volts, depending upon the constants used, and is capable of driving any class "A" grid to those limits. Even at plate supply voltage of the 150 v. the output can be over 0 db (6 milliwatts) without overload.

Tests with Different Input Impedances

Testing out the amplifier with medium-priced velocity microphones having the same movement but different impedance output transformers, to see how well the shot effect noise was covered, gave the following results: Two hundred ohms, fair. Five hundred ohms, good. Five thousand ohms, absolutely no background noise. One hundred thousand, no noise.

Using the next more expensive microphone, there was no detectable background noise from the amplifier, even with a 200-ohm input. As a test an input transformer, made by a reputable manufacturer and well shielded, was connected into the circuit. The gain, of course, went up, but although the transformer was four feet away from the nearest power supply it was impossible to

prevent it from introducing a noticeable background hum. Without the transformer, *i.e.*, with the normal circuit, the power supply could be brought within six inches of the input to the amplifier without picking up hum.

Power Supply Requirements

The amplifier was purposely designed to take as low a plate current drain as possible and operate at low voltage with the idea in mind that it might then become possible to incorporate in it such adequate a-f filtering that the device could be operated from the main amplifier power supply without trouble due to motorboating. Another advantage thus gained is that of ease of power supply filtering. That the theory works well in practice is exemplified by the fact that it is entirely unnecessary to use any choke coils in the power supply or any other circuit. It was found that a 325-volt center-tapped transformer working into a rectifier followed by a filter section composed of a two μ f. condenser, a high resistance and a twelve μ f. condenser was an adequate and hum-free supply. The drain of the device is only 0.6 ma. for the first section and 3.4 for the second, both at 150 volts. The amplifier has been used with power supply "robbed" from an ordinary radio set, without any resultant hum. As a choice of 6.3 or 2.5-volt tubes is available, in most cases, the filament supply can also be obtained from the same source.

Output Arrangements

The output arrangements of the amplifier are extremely flexible. It

is designed to work into a minimum load of 20,000 ohms. There is no d.c. present in the output circuit, and one side of it is grounded. If the pre-amp is mounted within a few feet or less of the main amplifier there is no necessity for the use of an expensive and relatively inefficient line-to-grid transformer as an input to the main amplifier. Instead an ordinary plate-to-grid transformer may be used, or the output may be connected directly to the grid, which may be returned to its cathode through a resistance or impedance. The gain of the pre-amp. is so high that the added gain given by the use of a coupling transformer is seldom required. If the pre-amplifier is mounted at a distance from the main amplifier it may be terminated in a standard plate-to-line transformer. It will be noted that any transformer terminating this amplifier is automatically parallel-fed.

Physical Layout

Such a circuit adapts itself to very simple layout. The physical dimensions of the complete amplifier, as shown on page 19, are 3 in. wide by 9 in. long by 2 in. high. This is about two inches longer than strictly necessary, but it allows insertion room at either end of the amplifier for large microphone and output plugs if these should be desired instead of the usual terminal strip. The space under the 6A6 socket is held clear of obstruction to permit the mounting of a volume control in any position. The control may be mounted on either side, top or bottom. This last method of mounting is a decided advantage when the amplifier is rack mounted. With this system as many as five amplifiers may be placed side by side, bottoms facing out, on a standard 19-in. rack panel to form a mixer. The mixer controls will then come out three inches from center to center, which is a most convenient distance. This makes possible a most inexpensive form of mixing panel in the usual high quality P.A. system. The loss sustained when the amplifier outputs are tied together is reduced in importance as their gain is so much greater than that of the usual pre-amp. With the volume control mountable on all four sides and the only connections to the equipment being made at either end the utmost flexibility in system layout is obtainable.



Automatic machines for winding paper capacitors

High-Speed Radio Production

Radio, a seasonable business, calls for high-speed production during the Fall months. Methods used at the RCA Camden plant are representative of this modern ranking industry

By **PUZANT HENRI JERYAN**
*RCA Manufacturing Company
 Camden, New Jersey*

IN the annals of industrial progress in this country, probably nothing has been so phenomenal as the development and rapid growth of the home radio receiver business. Starting from nothing in 1920 it has become one of the large industries in point of employees, dollar volume, and unit sales. Because of the large scale production which must be accomplished in a relatively few months of the calendar year, quantity or mass production methods must be used. A description of the making of home radio sets as carried out at the RCA Victor plant at Camden is given in the following pages. At this plant, of course, all manner of electronic products are made. Microphones, pick-ups, electric chimes, complete transmitters for broadcast, police and aircraft and other mobile and fixed services, fire-arm detectors for prisons, direction finders, laboratory testing equipment, phonograph recording and re-

producing equipment for the home, theater or other purposes, 16-mm motion picture cameras and projectors all are part of the production activity of this plant.—THE EDITOR.

• •
 There is much activity involved in the introduction of a new receiver

into the market. Generally two to three months elapse from the original conception to the final production of a new model. Part of this time is spent on developing the new unit based on the current field requirements, as determined by the sales department, and fixed by the new technical possibilities offered by



Joints of transformer coil leads dipped in silver solder insure per-



Machine for fastening loud speaker cone rims to speaker housing



Speakers, held against openings to soundproof booths get final tests

the research and engineering department. With the cooperation of these two departments, the general specifications of the new line are determined. The engineering department prepares all the schematic drawings and works out the physical details of the chassis speaker, and component parts. Several experimental sets are then built in the advance-development shop which constitutes a link or coordinating agent between the research and design laboratories, and the manufacturing department. Its creation in the Spring of 1934 at RCA Victor established a great step toward production efficiency. Processing and test equipment groups are included in this section.

After the completion of these experimental receivers, and their final operating tests by the engineering department, they are studied by all concerned in the manufacturing and service departments. Comments and suggestions are considered by the engineering department, and changes are effected when necessary. The development shop builds additional samples for field tests. These are sent to field engineers, located in all sections of the country, who study and report on the performance of the receivers in their locality.

The advance-development shop has played an important role in deciding whether the model is suitable for manufacture. Thus, before the expensive tools are made and quantity production started, all possible manu-

facturing difficulties have been straightened out and samples have traveled to all corners of the country for field tests. For this reason, not all models prepared by the development shop reach the market.

The manufacture of the component parts and sub-assemblies form the major portion of this company's activities considering the number of employees, number and types of machinery used, and the amount of floor space made available for this work. This manufacture is subdivided into sections by the nature of

the component parts made. Since each section supplies parts for all divisions, viz., for home receivers as well as for photophone, transmitters, replacement parts and for a multitude of other special apparatus, they can, by their size and output volume, be considered as manufacturing plants of their kind.

RCA Manufacturing Company makes most of the component parts used in their equipments. Certain items, however, are bought from outside vendors. These are parts which are highly specialized in their man-

ASSEMBLY

1 *In long lines of moving belts, chassis are assembled by girls carefully trained to wield soldering irons and tools*





Preparation of front panels for cabinets. RCA Victor's wood-working machinery is spread over some 600,000 square feet of floor space

ufacture or carry special patent rights. Variable and electrolytic capacitors, resistors, switches, special cables, are some of the purchased parts.

Actual building of the radio chassis is accomplished on the well known assembly lines, where the units are put together and wired in progressive steps. They are located on one floor, extending 650 feet, at one end of which is a large storeroom where all required component parts are accumulated to make them readily accessible to various points

of assembly. There are six assembly lines on this main floor. Each is approximately 360 feet long and has 120 to 140 operators lined throughout its length for individual assembly and soldering operations. The output of each line is from 400 to 800 chassis per 8-hour working day.

The first section of the assembly line is termed "feeder line." It is a 90-foot long bench where the cadmium plated chassis base is brought for its progressive assembly. Here the tube sockets, lugs and miscellaneous brackets are rivetted. The chassis

is then passed from one operator to another so that the major component parts, such as power and audio transformers, i-f and r-f coils, electrolytic capacitors, tuning condensers, volume and tone controls, etc., are placed in position.

From the feeder line, the chassis is carried to the "conveyor line," which is a continuation of the main line. On this the chassis travels at a constant rate of speed. While it is thus progressing, each operator does her small share of adding smaller parts, or wiring and soldering various connections.

To expedite the assembly on the conveyor, several sub-assemblies are prepared elsewhere and brought to the conveyor operator for insertion and final connection in the chassis. The tuning mechanism, the r-f tuning unit, ("Magic Brain"), and resistor boards are some of these. The latter is a cluster of carbon resistors assembled on a small cardboard with terminals. It is readily fastened to the chassis and the proper connections are brought to it. This progressive assembly may, at first, seem relatively simple. Its smooth and efficient operation, however, is quite involved. Virtually all operators are female; they are more adaptable for this type of work. Time and motion studies must be closely followed for continuous and rhythmic operations on the line. The foreman of the line

2 *One operation on the feeder line. Riveting of sockets and miscellaneous components to the chassis proper*



3 *Another step along the feeder line. Here the major component parts, coils, condensers, transformers are added*



must also be familiar, to some extent, with the ability and adaptability of each operator. He must, for example, know that the faster operator is the more accurate operator and, therefore, is more eligible for this work. The quality of workmanship must be perfect. There are male inspectors stationed at intervals, for every 15 to 20 operators on the line. Each joint is numbered and the inspectors know the responsible operators for each joint. At the end of the line, after the chassis is complete, there are three or four electrical continuity checkers to insure that the chasses are correctly wired, and soldered. The rate of speed of the conveyor is also important. It has been experimentally shown that there is a distinct rate above or below which the quality is impaired.

Nowhere is the adage of a chain being no stronger than its weakest link more applicable than here. A steady flow of the right material, at the right time and at the right place, must be maintained while the line is running. Lack of this will seriously delay or temporarily suspend production. To illustrate, let us assume that while the line is running, an operator discovers that she is supplied with a wrong resistor board to be assembled to the chassis. Immediately, several chasses are taken off the conveyor while the foreman rushes to the storeroom and to material-control men to see if the right

boards are available. Should it be necessary to wait a half-hour for the new part, the conveyor line is stopped for that period and all the operators rest idly. If the resistor board is not available and cannot be supplied for that day, the foreman then has only one solution—a shut-down.

Despite these critical conditions, shut-downs are uncommon. When it is realized that there is a number of different models each year, most of which require different types of component parts, it will then be easy to appreciate the complicated work that the material-control men have to go through.

Conveyor Line vs. Bench Assembly Line

In the early days, the chassis was assembled on bench lines. Each operator had possession of the chassis from five to ten minutes, performed several operations, and passed it to the next operator. In this way, the whole chassis was assembled by less than 25 operators. Last year, the merits of the bench assembly were brought up again and after experiment it was found more practical and economical to build short orders, or chasses of approximately 300 per day, on bench assembly lines. The rest, usually from 400 to 800 units per day, would be assembled on conveyor lines. With this arrangement, the company now has seventeen additional assembly lines which are of

the bench type. Short orders, such as police and aircraft receivers, amplifiers and special export models, are also built on these lines.

Aligning

After the assembly and wiring, the tuning mechanism is adjusted and checked. Tubes are next inserted in the completed chassis, which is then taken, on overhead conveyors, to the aligning section. Here the i-f trimmers are aligned first, then the r-f signals are peaked at selected frequencies on all bands. R-f signal frequencies, modulated at different a-f voltages for identification, are supplied by crystal oscillators. In bench assembly, the alignment is completed on the bench line itself. Sensitivity, selectivity, fidelity, hum and a-v-c action are also checked.

The aligned chassis is next carried to a focal point where the finished cabinets and the speakers also meet. The motorboard and turntable assembly of combination receivers are also brought here. The whole instrument is then assembled and made ready for a final operating test in individual booths.

"Trouble"

It is a fact that in all radio manufacturing plants, the rejections of completed chasses at various points of test are high compared to the

--- ASSEMBLY

4 After the components are in place, wires are attached and soldered, continuity tests must be made



5 Modern radios have many circuits to be aligned before local and foreign stations can be heard



manufacture of other electrical appliances. There is no scrap, however, and all defective chassis are corrected by trouble shooters.

Mechanical defects are more frequent now that the tendency in modern receivers is to be more gadgety, especially in the tuning mechanism with its band-changing system, the dial ratio changer and its micro-pointer. This mechanism alone is more involved than a vacuum cleaner or a washing machine. Some manufacturers have gone further by adding automatic tuning, operated either by a button or by an electric clock. Other opportunities for mechanical trouble are: the proper assembly of parts, contact of sockets to tube prongs, operation and electrical contacts of band switches and miscellaneous screwing, rivetting and soldering operations. An average radio chassis contains approximately 300 soldered joints. If there are fifteen defective joints in one hundred chassis involving 30,000 joints, the defective workmanship, based on the total number of joints, will be represented by 0.05 per cent., which, at first glance, may seem negligible, nevertheless these fifteen defects may cause fifteen inoperative units, resulting in 15 per cent chassis rejection.

Electrical troubles were most prominent when the first all-wave receivers came into existence. Since then, however, most troublesome

items have been remedied, chiefly by better design. A five-band receiver may have in its tuning and oscillator circuits, three sets of five coils; each with its trimmer capacitor. On shorter wave lengths, the inductance and capacity of these coils and trimmers respectively become very critical, and rigid and close tests must be maintained in their individual tests. Small variations in values and accumulation of the tolerances, however, will affect the sensitivity of the receivers. The proper dressing of the leads also becomes very important in high frequency tuning circuits. The relative positions of these leads are kept constant as much as possible with the exception that slight variation performed by an experienced trouble shooter will, at times, compensate and cure a reject condition.

Quality

In the manufacture of an intricate instrument like the receiver of today, the work of inspection and test becomes of paramount importance. A typical 8- or 10-tube receiver, from the assembly of its component parts to the finished instrument, will have over 300 inspections and tests performed on it. The quality men are most active in their checking to see that all manufactured products conform to the specified standards of quality. In this, the research and

experimental laboratories are also of great assistance. The value of these inspections can always be realized in terms of dollars and cents, as well as in perfection of quality in the field.

After the alignment of the chassis and its subsequent installation in the cabinet with the speaker, the instrument is ready to operate. However, a final individual operating test mentioned above assures faultless performance in the hands of the customer.

Inspection

For the regular analysis of the finished instruments, an elaborate sample check section is situated in a strategic location where the completed instruments pass on their way to the shipping department. From 50 to 100 instruments are picked at random every day. Thorough inspection for design, construction, workmanship, and complete operating tests are effected on each instrument. This constitutes not only a check on the receiver itself, but also on all test equipment used on the receiver.

The Service Division, with its staff of field engineers in all sections of the country, brings its contribution in preparing regular quality reports from the field. Such reports forestall difficulties in service and improve relations with the final purchaser.

6 *Automobile receivers—another huge annual market—are aligned here by a cathode ray tube*

7 *A final assembly test. Even after this, a few sets are picked at random at the shipping room*



A Self-protecting Cathode

. . . which prevents damage to emitting surfaces of mercury vapor tubes during the warming up period. Useful for two- and three-element rectifiers, for hot-cathode ultra-violet lamps

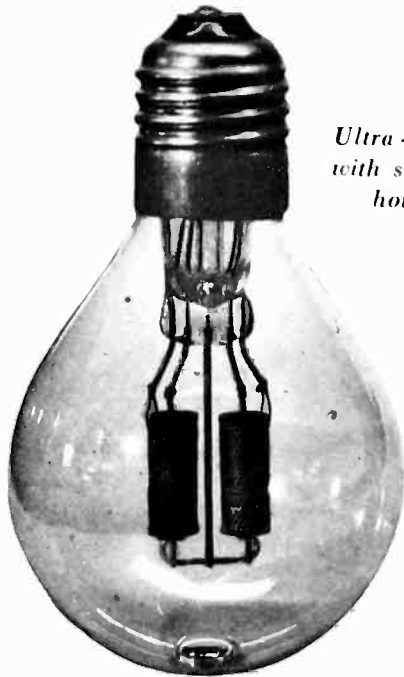

Ultra-violet tube with self-protecting hot cathode

By DR. E. F. LOWRY

Research Laboratories
Westinghouse Electric
& Manufacturing Company

AN IMPORTANT consideration in the use of hot cathode mercury vapor tubes is the period during which the cathodes are warming up. It is imperative, with the larger tubes at least, that no plate load be applied until the cathode has reached a temperature which insures that its thermionic emission exceeds the value of the peak plate current to be drawn. Failure to make provision for this interval results in the formation of a cathode spot on the emitting surface with consequent stripping off of considerable amounts of coating.

Numerous attempts have been made to develop a cathode having the thermionic efficiency of the standard oxide coated type but which is not subject to this stripping action. One method employed is to incorporate the active material in the core metal or to sinter it into very close adhesion to the core. Another scheme

utilizes what we may call the "pellet" form of cathode, in which a large excess of active material is firmly pressed into a pellet or slug. This pellet is then inserted in a helical tungsten heater with which it is in close contact. A third method consists in impregnating a closely wrapped cylinder of many layers of fine nickel gauze with the active material. Insofar as the author is aware, at least most of these efforts have met with only moderate success.

The method commonly employed in practice of handling this difficulty is to insert in the anode circuit of the tube some type of time delay relay having a delayed closing time adjusted to the heating time of the particular cathode used. Most of these relays are either of a mechanical or thermostatic type. A few thermionic relays have been developed. In one of these developed by Ramsey¹ a condenser in the grid circuit of the gas discharge tube is charged through a rectifier and the charge then allowed to leak through a high resistance. The grid bias thus rises slowly to a value above which the arc discharge will start. In this device an auxiliary switch is required to remove the charging potential from the condenser. Another method due to Stogoff² alters the grid bias of the gas tube by means of an indirectly heated cathode high vacuum tube suitably connected in the circuit. Stogoff varies the heating time of the cathode of his auxiliary tube to meet the required delay interval. A variation of this scheme was recently described in *Electronics*³ in which the high vacuum tube with slow heating cathode serves to close a relay in the anode circuit.

A form of cathode has recently been developed by the author which serves as its own time delay relay. This cathode consists essentially of two portions: A directly heated por-

tion or filament and an indirectly heated portion closely surrounding the filament and composed of finely perforated metal. For purposes of brevity this indirectly heated portion of the cathode will hereinafter be referred to as the "screen." The screen is coated with active material only on its inside surface and is so arranged that it totally encloses the filament. All electrons leaving either portion of the cathode must pass through the perforations in the

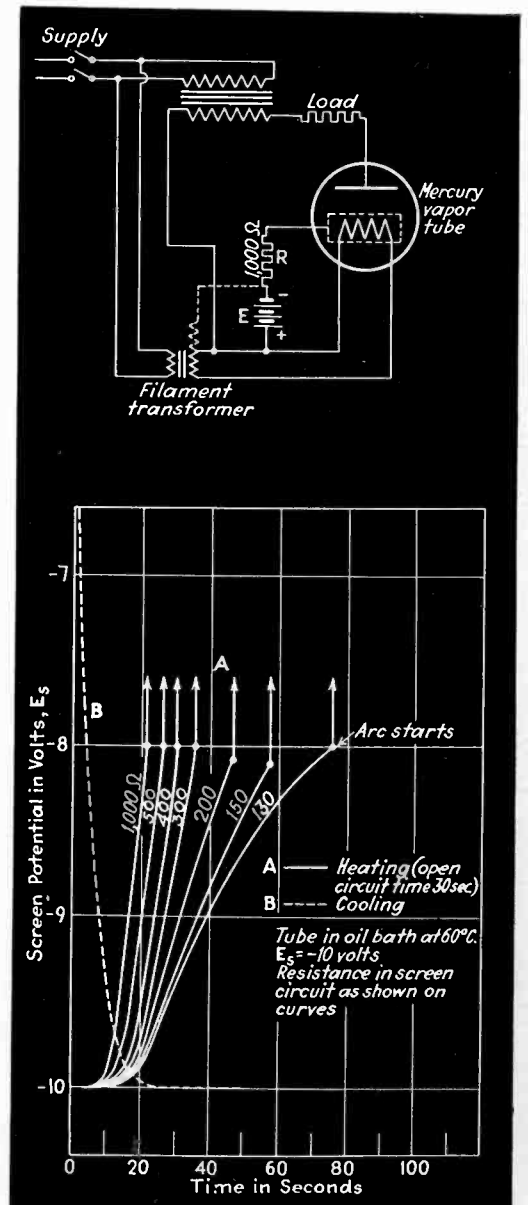
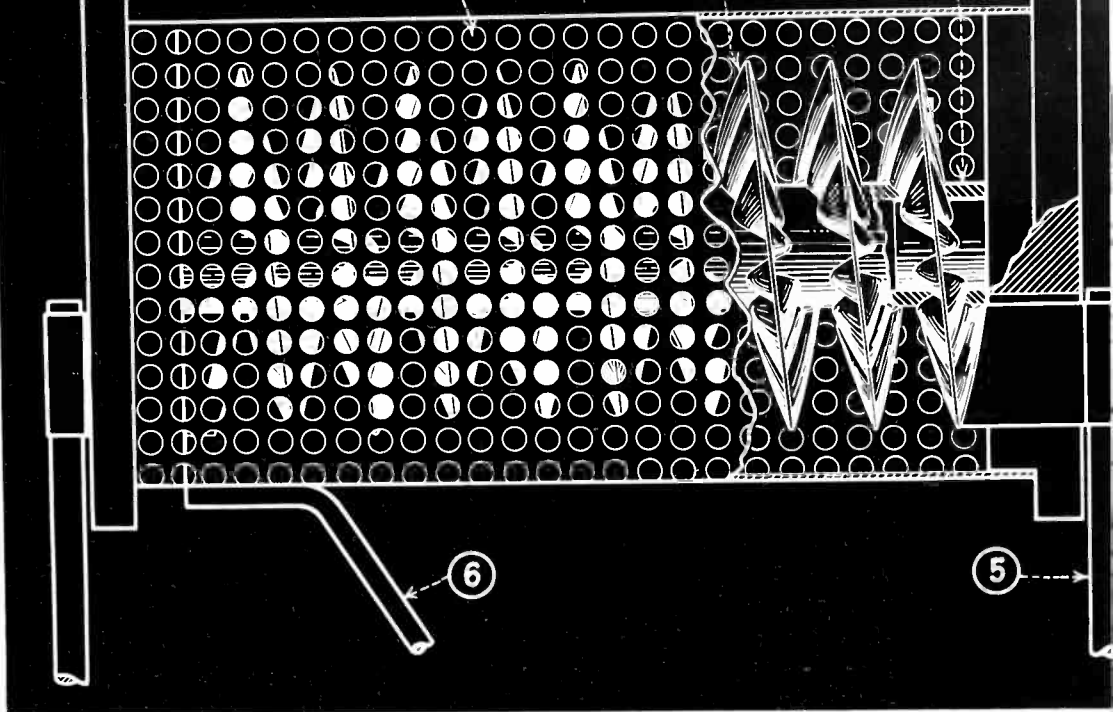

Fig. 1—(Above) Screen circuit.

Fig. 2—Screen potential vs. heating or cooling time of cathode

Fig. 5—Diagram of cathode showing simple, rugged construction. 1—filamentary portion of cathode. 2—screen. 3—filament slipped over ceramic tube 3, which fits over studs on ceramic disks, 4. Filament ends project through slots in the disk and are welded at 5 to their respective leads. Screen fits over shoulders on disks 4. Screen lead is at 6



screen. The screen may or may not be connected directly to the filament, depending on operating conditions. For certain purposes, particularly where the operating temperature is high and the tube circuit is subject to short outage times of from 15 seconds to 2 minutes, it is preferable to connect the screen to the filament through some such circuit as is shown in Fig. 1. Here E is a source of potential (battery or transformer) which will maintain the screen negative with respect to the

filament at least during the half cycle in which the anode voltage is positive.

The operation of this device is as follows: When potentials are applied

to cathode and anode circuits, the screen behaves like a grid with a very high control factor, thus preventing the arc from starting. As the filament warms up the screen also warms up by radiation from the filament. It finally reaches a temperature at which it is also thermionically active. In the screen circuit the following condition now exists:

$$-e_s = -E + IR$$

where $-e_s$ is the potential of the screen with respect to the filament at any instant. Obviously this potential is a variable depending on I , the thermionic current from the screen to the filament. It now appears that as the screen warms up e_s will approach 0, finally arriving at a value at which the screen will no longer prevent the electron current from passing to the anode. Conversely, when the cathode circuit is opened e_s will rapidly build up to a value which will prevent re-ignition of the arc. In applications where no potential is applied to the screen, it is usually desirable to retain some resistance R between the filament and screen portions of the cathode, otherwise the screen may absorb more than its share of the load, thus becoming seriously over-heated.

The curves of Fig. 2 show how this cathode operates. The data for all curves were taken with a recording voltmeter. Here are plotted values of the screen potential as a function of the time in seconds after closing or opening the cathode and anode circuits. The tube used for the purpose of these tests was of the size of the KU-628, but contained no

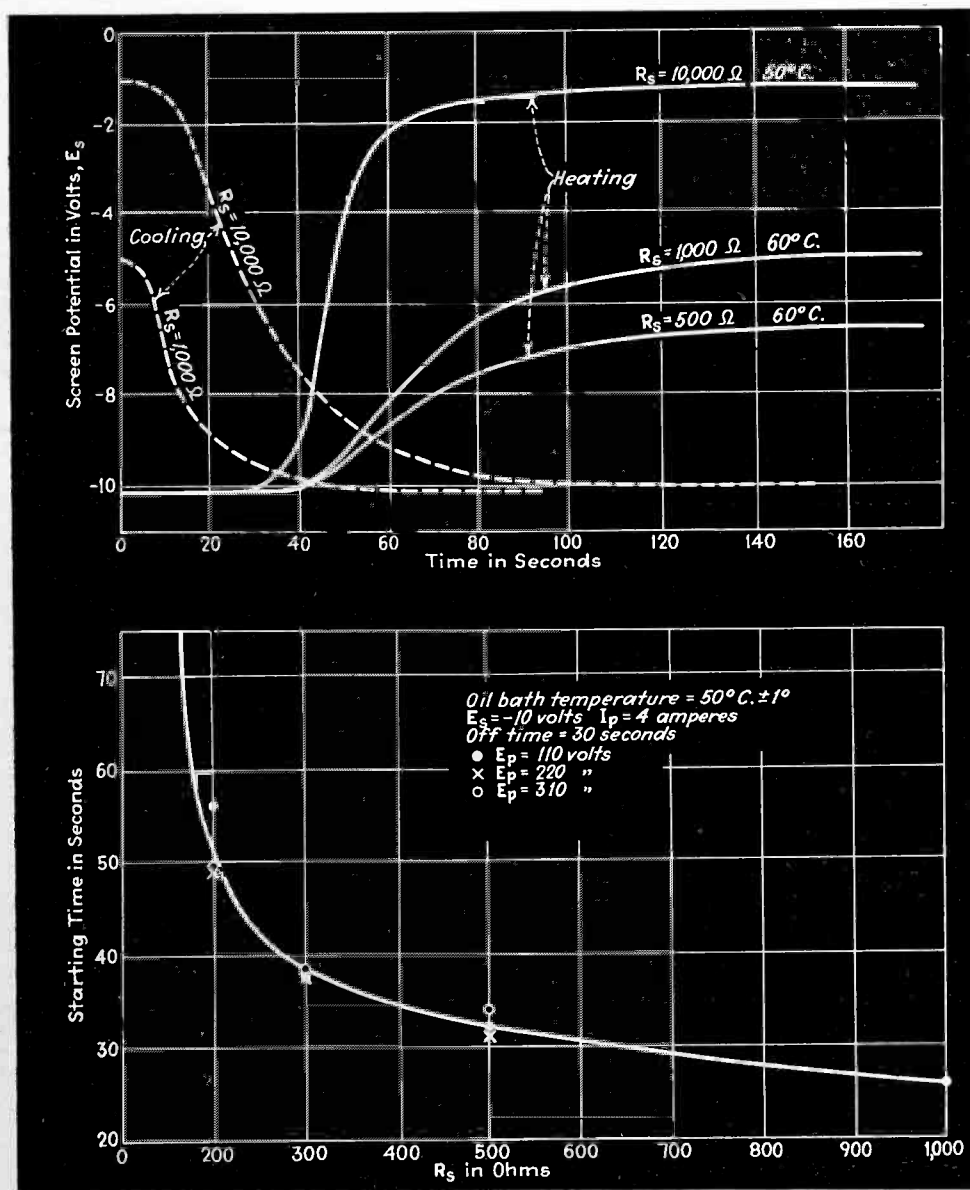

Fig. 3—Variation of screen potential with time

Fig. 4—Starting time vs. R_s for various anode potentials

grid. This tube has a peak anode current rating of 16 amperes and an average anode current rating of 4 amperes. The cathode operates at 5 volts, 11.5 amperes with a normal heating time of 30 seconds. For the purposes of this test the tube was completely immersed in oil at 60° C. The anode voltage was 110 volts d.c. applied through a limiting resistance. Ten volts storage battery was used to supply the screen potential through the various resistances indicated on the individual curves (A). It is readily seen that the screen potential changes with time to -8 volts, at which value the arc strikes and the screen potential at once rises to 0 or above. When the circuit is opened the screen potential rapidly falls to a value where it again controls the starting of the arc (Curve B). Curve (B) is only a representative of a family of curves similar to (A) since the rate of change of potential is a function of

the resistance R as well as the time T . All the (A) curves were taken with a uniform open circuit time of 30 seconds and a d-c plate load of 4 amperes.

The heating curves of Fig. 3 are similar except that they were taken with an open circuit time of 15 minutes to insure that the cathode was cold. No anode potential was applied and the filament circuit was closed long enough for an equilibrium value of the screen potential to be reached. The curves of both Figs. 2 and 3 indicate how amenable this method of cathode protection is to regulation. The re-starting time of the tube can be set for any desired value by proper choice of the screen circuit constants.

Figure 4 presents similar information in a slightly different fashion and also shows that the starting time is nearly independent of the anode voltage. Other tests not plotted show that this is true at least

to 1,100 volts. Another way of saying this is that the screen while cold behaves like a grid with practically a vertical characteristic.

A good illustration is the application of this self protective cathode to hot cathode ultra violet lamps such as the G-1. In this instance both parts of the cathode are connected without an intermediate resistance or source of potential. It has been found that the use of screen cathodes in this lamp increases the life several-fold. In this application the screen acts as anode during the inverse half cycle.

In conclusion the author wishes to express his indebtedness to Dr. H. N. Kozanowski for his assistance in the preparation of this paper.

REFERENCES:

- ¹H. T. Ramsey, U. S. Patent 1,939,462.
- ²P. E. Stogoff, U. S. Patent 1,973,123.
- ³"Thermionic Delay Relays for Cathode Protection," L. D. Miles & M. M. Morack, *Electronics*, pp. 124-125, April, 1935.

Dr. G. A. Campbell Retires

Filter inventor completes thirty-eight years of service at Bell Laboratories

THE first of December marked the retirement of Dr. George A. Campbell after thirty-eight years of service with the American Telephone and Telegraph Company and its research branch, the Bell Telephone Laboratories.

Dr. Campbell is known chiefly for his invention of the electric wave filter, although he has made many other notable contributions to the telephonic art. Among these might be mentioned his exhaustive studies of "cross-talk," as a result of which important advances were made in the telephone engineering field.

The almost universally-used four-wire repeater circuit is based on Campbell's work, as was the practical form of the two-element two-way repeater which preceded it. Those familiar with the history of telephone repeater practice will remember the inordinate difficulties of maintaining line balance when the two-way one-element repeater was



used; it was Campbell's suggestion of applying a balancing network which promoted the acceptance of the "22 type" repeater.

Sub-station circuits, articulation testing, and measuring devices—all of incalculable value to the art—are achievements of his.

It is interesting to note that Campbell, entirely independently of and co-

incident with the late Michael Pupin, discovered the principle of "loading" a telephone line to improve the transmission. This improvement, in both the Campbell and Pupin inventions, was predicated upon the use of lumped inductance in series with the line, the coils being spaced with due regard to the highest frequency to be transmitted. As is well known, in communication engineering circles at least, Pupin was awarded the patent for this invention.

However, Campbell had earlier foreseen the eventual need for selective circuits, and his mathematical analyses of the loaded line—which were far more detailed than those of Pupin—led to the invention of the wave filter.

Campbell's writings properly take their place at the head of any listing of scientific publications. Space limitations prohibit even a brief bibliography of these works, but we can think of no more fitting tribute than to suggest the reprinting, by A. T. and T. or the A. I. E. E., of Campbell's classic "Cisoidal Oscillations." Its present unavailability leaves a serious gap in engineering literature.—W. W. WALTZ.

POWER SUPPLY FILTER CURVES

By W. W. Waltz

See reverse side for description and instructions for use

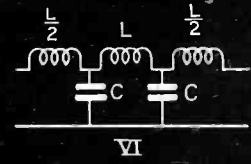
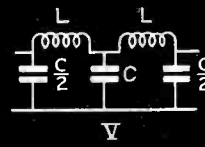
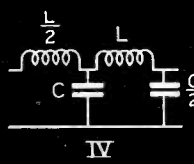
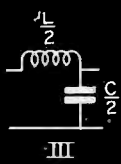
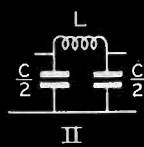
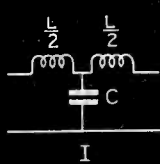
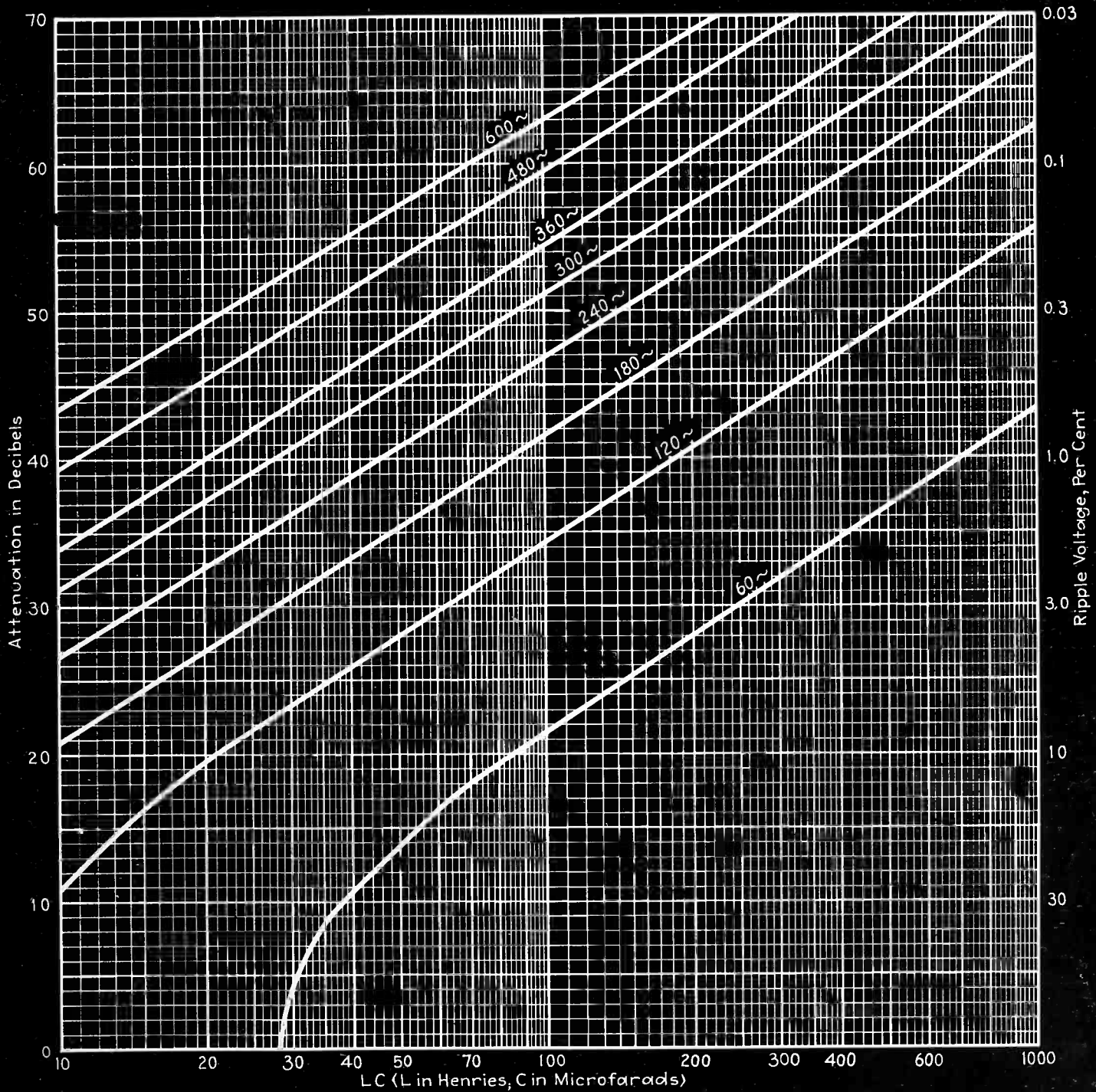

ELECTRONICS REFERENCE SHEET

Power Supply Filter Curves

Attenuation and ripple voltage curves of typical low-pass filter sections, such as are commonly used in smoothing the output of power-supply rectifiers, plotted as functions of the inductance and capacity employed, for 60-cycle a.c. and its harmonics

IT is a little appreciated fact that the attenuation performance of low-pass filters of various configurations can be predicted from a knowledge of the product of the capacity and inductance values employed. Using LC as a parameter, curves of attenuation (and of ripple voltage which depends of course on the attenuation) may be plotted for various frequencies, and for various different circuit arrangements. Such curves are printed full scale on the reverse side, and reproduced for convenience in the lower right hand corner of this page.

The curves give the attenuation loss of low-pass filters, such as are used in rectifier systems of amplifiers and receivers, as a function of the product of the series inductance and shunt capacity. The loss, as read from the chart, applies without change only to the structures I and II. For structure III, the loss read from the chart must be divided by 2; for IV the chart loss is to be multiplied by 1.5; for structures V and VI multiply the loss shown on the chart by 2.

Curves are shown for frequencies up to and including the tenth harmonic of the usual 60-cycle supply. Since many of these higher harmonics appear in the rectifier output, it is advantageous to be able to predict the amount of attenuation which they receive from a given filter. However, the curve of greatest interest will be that for 120 cycles, that being the lowest frequency which appears in the output of a full-wave rectifier.

Sections like IV, V, and VI in which the coils have different inductance values, must be changed by the well-known methods (see page 282 of "Transmission Circuits for Telephonic Communication" by K. S. Johnson) to the equivalent T or π structure before applying the chart.

As an example of the use of these

By W. W. WALTZ

curves, assume a filter of type IV. Let the series inductance (L) be 30 henries; the shunt capacity (C) 8 μ fd. Entering the chart at the product of these values, i. e., at 240, we find that the 120 cycle attenuation will be 42.3 db. However, for this type of section we must multiply this by 1.5, which gives 63.4 db as the attenuation of the filter at 120 cycles; at the tenth harmonic, 600 cycles, the attenuation will be 1.5 times the chart value of (about) 71 db, or 106.5 db.

Reflection loss, due to improper termination, need not concern the

user of this chart; it is serious only below the cut-off frequency and all we are concerned with in that range is d.c. Actually, whatever reflection loss there is will function to increase the attenuation above cut-off; the same applies to the effect of the Q of the inductance coil although the sharpness of cut-off will depend upon this latter function.

The ordinates on the right side of the chart give the ripple voltage as a percent of that at the filter input. Terman (see page 408 of his "Radio Engineering") gives the amplitudes of the ripple frequency and its second and third harmonics as 0.667, 0.133, and 0.057, respectively, times the d-c voltage at the filter input.

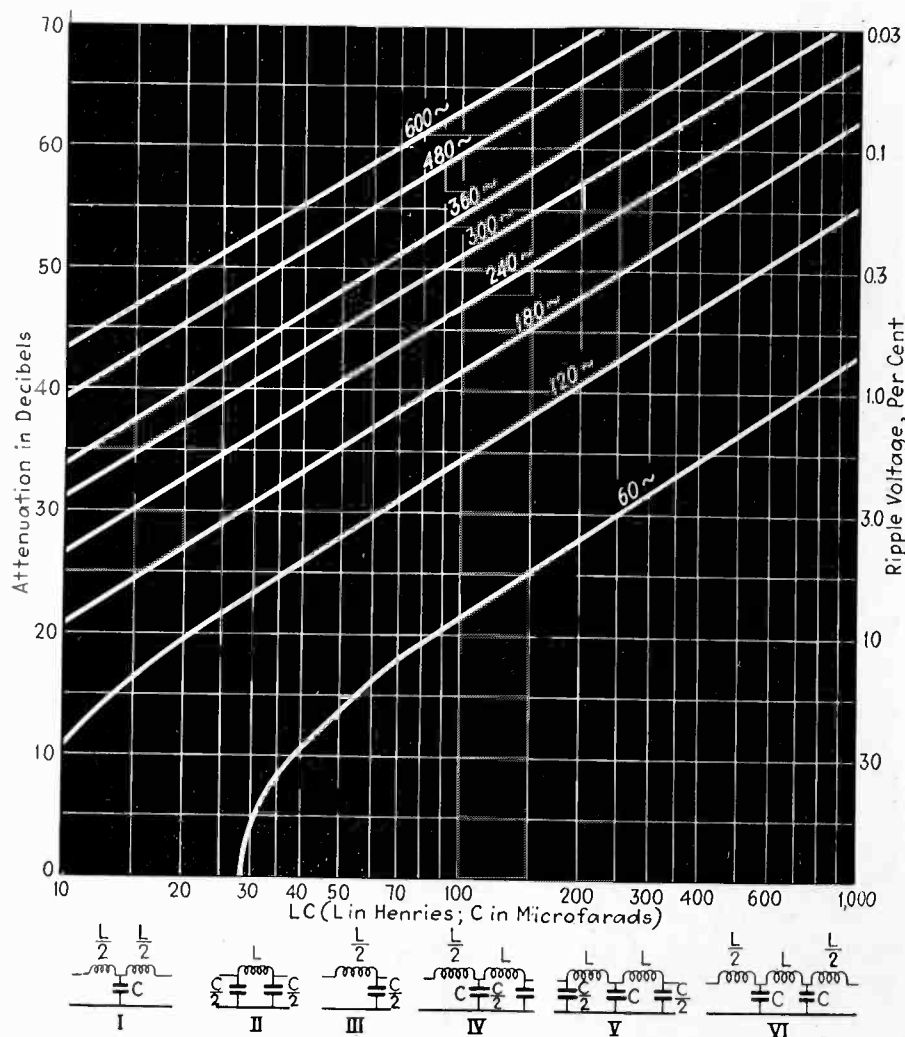

Small-scale reproduction of the filter curves, for convenience in referring to text. Use curves on reverse side for accurate work

"Explorer II" Takes Tubes Aloft

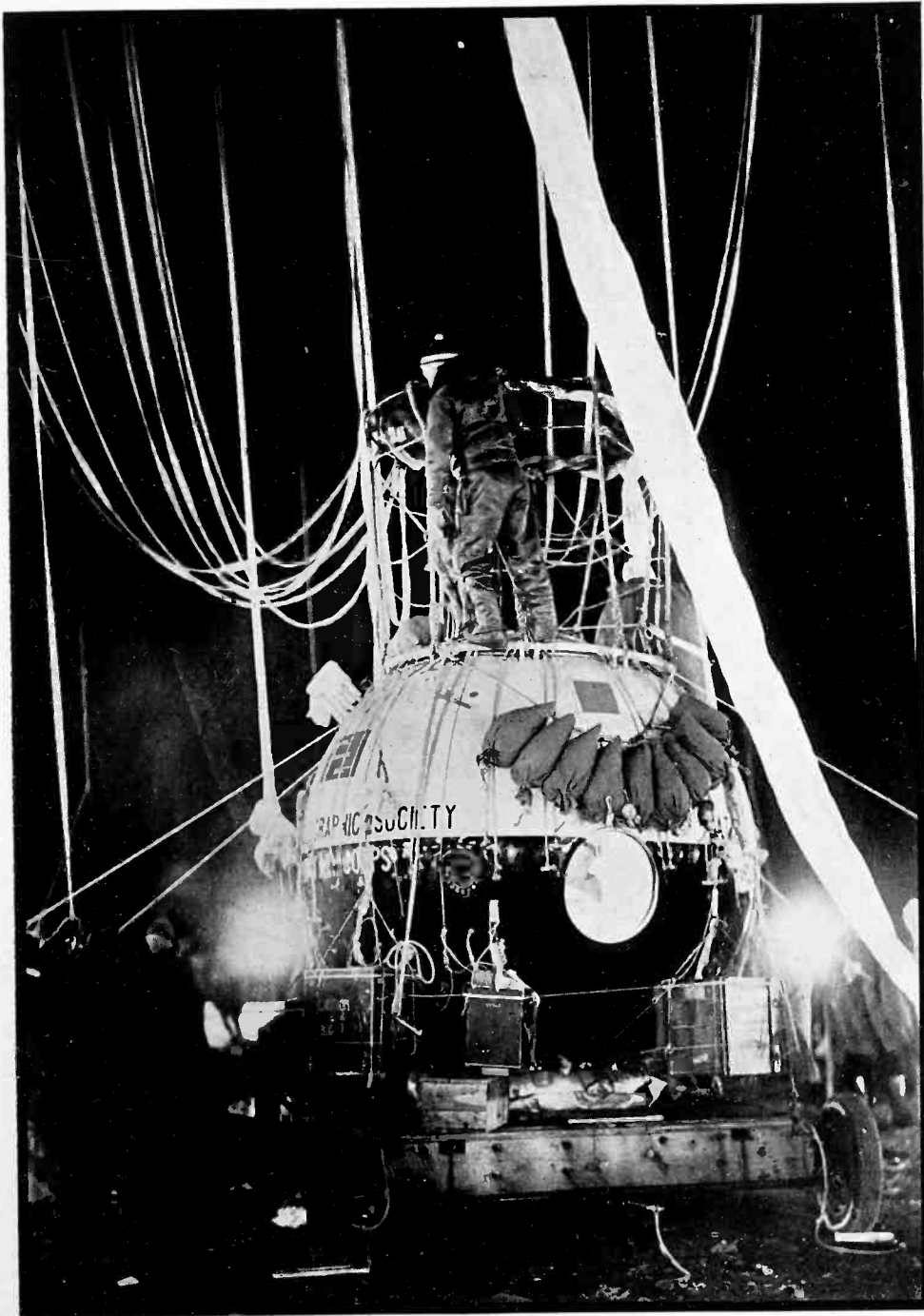

Explorer II gets ready to depart for the record-breaking flight into the stratosphere

Cosmic ray counters, air conductivity apparatus, complete communication with earth — all by electron tubes

ray "telescopes" for measuring the intensities of corpuscular cosmic rays from 5 different angular elevations, at various azimuths, and at various elevations above the earth's surface, was carried in the gondola of the balloon. It is expected that the measurements made with this apparatus will lead to much more complete knowledge of the methods of absorption of corpuscular cosmic rays by the earth's atmosphere, and of the effect of the earth's magnetic field in deflecting them from their lines of initial incidence.

Each "telescope" consists of a group of 9 Geiger-Müller counters, in 3 collinear groups, provided with coincidence amplifying circuits, so that only those rays which simultaneously pass through a counter of each group will be recorded. Such an arrangement is aptly called a cosmic-ray telescope, since, like an astronomical telescope, it is only sensitive to those rays which enter within a definite solid angle, determined by the geometry of its parts, and it can be pointed in any desired direction.

The high intensity of cosmic rays in the stratosphere makes the use of small counters necessary, for accurate measurements. Consequently the number of counters and number of telescopes used in parallel must be correspondingly increased, in order to get good statistical accuracy in measurements made within the time of a stratosphere flight. The present apparatus employs 210 counters,—very probably the largest group ever used in any single experiment.

THE scientific equipment carried by Captain Albert W. Stevens and Captain Orville A. Anderson in the gondola of the Explorer II during the 1935 record-breaking balloon expedition into the stratosphere, sponsored by the National Geographic Society and the United States Army Air Corps, illustrates a number of novel applications of vacuum tubes which are of particular interest to readers of *Electronics*.

A major scientific object of the expedition was the study of cosmic rays. W. F. G. Swann, Director of the Bartol Research Foundation of the Franklin Institute, and G. L. Locher, and W. E. Danforth of the Institute designed and installed in the gondola equipment for investigating the variation of cosmic ray intensity with direction in the stratosphere. The apparatus constituting, in effect, a battery of 20 cosmic-

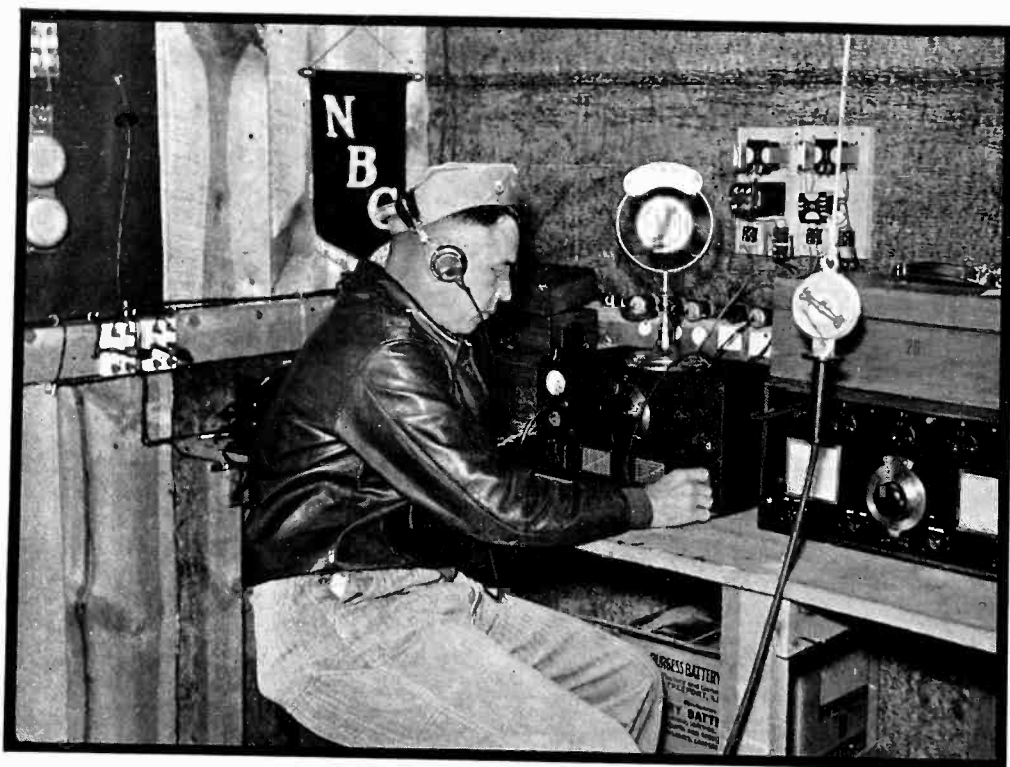

Listening post at edge of bowl from which Explorer II took off

Geiger-Müller counters have been steadily increasing in importance, during the last 5 years, for physical researches involving measurements of various radiations of low intensity. Counters have extraordinary sensitivity, by virtue of their ability to record *individual* ionizing rays, even if only a *single ion* is liberated in the counter; they are rugged in construction, and their discharges can be amplified and recorded by simple radio circuits.

The figure shows the essential parts of a Geiger-Müller counter. A wire, *W*, is stretched along the axis of a hollow metal cylinder, *F*, enclosed in a glass cylinder. After suitable treatment of the electrode surfaces, the tube is filled with a suitable gas, usually at about 1/10 atmospheric pressure. A negative potential, *V*, is applied to the cylinder-electrode; the wire is connected through a small capacity, *C*, to a vacuum-tube amplifier, *A*, or an electrometer, and through a high resistance, *R*, to ground. The value of *V* is adjusted so that it is *nearly* enough to cause a brush-discharge between the electrodes. When in this sensitive condition, any ray, *Q*, passing through the tube and liberating one or more ions within *F*, initiates a small discharge in the counter. This discharge, recorded by *A*, is automatically quenched, in a few thousandths of a second, as a result of the lowering of the voltage across the counter by the *Ri* drop in *R*;

after this, the tube is again sensitive.

The particular type of counter used in the flight is also shown. It was developed by Dr. Locher, with the valuable assistance of Mr. A. G. Nester, to meet the stringent requirements of stratosphere measurements. The cylinder is of thin copper, 3 cm. by 1 cm.; the wire is 3-mil tungsten; the gas is a mixture of 94% argon and 6% oxygen, at 8 cm. of mercury pressure. Some 559 of these tubes have been used in the last three stratosphere flights made in this country. Operated with $V = 800$ volts, $R = 500$ megohms, and $C = 5 \mu\text{f}$, they recover their initial sensitivity in less than 0.002 seconds after a discharge,—a very desirable characteristic where radiation of relatively high intensity, such as that in the stratosphere, is to be measured. Counters similar in principle, but somewhat modified in form, are also used for measuring weak ultraviolet light, x-rays, gamma-rays, and for counting particles emitted by radioactive substances. They are especially valuable where the intensities to be measured are small.

The diagram of a counter telescope is given in simplified form. This is generally known as a "triple-coincidence" arrangement; discharges of 3 collinear counters, *A*, *B*, and *C* are recorded only when they are simultaneous within a few millionths of a second. The circuit is an adaptation of the ingenious one in-

vented by *B. Rossi*, in which three amplifying tubes act, essentially, as three closed switches in parallel controlling the current in a single circuit: only when all three tubes are cut off, (by simultaneous pulses from counters *A*, *B*, and *C*) is there an appreciable pulse applied through *C*, to the grid of a relay-tube (thyatron) which actuates the ultimate recorder. Coincidence counters are usually used only for cosmic rays; unless the walls of the counting tubes are very thin, only cosmic-ray particles will have enough energy to penetrate two or more tubes in succession. Discrimination against radioactive radiations is thus pro-

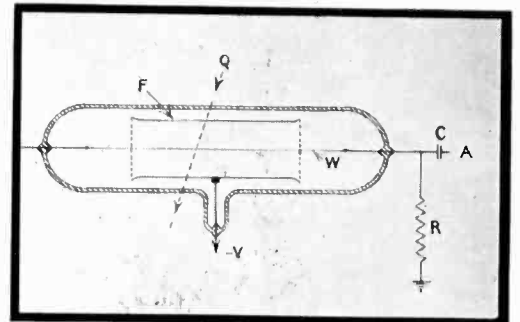

Essentials of Geiger-Müller counter

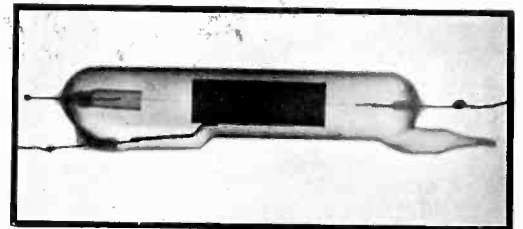

Typical cosmic ray counter used on the flight

vided. Spurious impulses, due to simultaneous discharge of all the counters by *different* rays, are made very few, by use of a triple-coincidence arrangement.

In the present apparatus, it was very necessary to economize on weight, space, and, especially, battery power. Accordingly, each set of 3 amplifying tubes (6C6) serves for two telescopes which are side by side, pointed in the same direction. Also, each counter element comprises 3 counting tubes connected in parallel, each with its own resistor and coupling condenser. The sensitive areas of the telescopes are 3 cm. by 3 cm.; the outside units are 9 cm. apart. This provides for the registry of rays entering within a square-based pyramid of 36.9° vertex angle. The use of a smaller angle would be desirable, but is not feasible for observations of such short duration.

The axes of the telescope units were inclined at angles of 0°, 10°, 30°, 60°, and 90° to the horizontal.

A duplicate set of telescopes, mounted at the same angles as the others, was also carried. The structure of these differs from that of the ones described in that the pairs of telescopes are separated by a "wall" of six long, thin, counters, which shield the telescopes against non-collinear groups of fast particles which might otherwise set off all

Stevens' timer, on a strip of continuously-moving photographic paper. The former method gives the total number of impulses occurring in half-minute intervals, and the latter gives the distribution of impulses of the various telescopes with time. An accurate watch and a compass are photographed with the recorders.

A second important scientific project of the 1935 flight was the study of the electrical conductivity of the air at different altitudes. Dry air

near sea-level is a very poor conductor of electricity. When the gases of the air become ionized, the electrical conductivity increases. The marked increase in conductivity at high altitudes is due to the increase of ionization and the increase in the mobility of ions at those levels. The effect of such increase in conductivity upon radio-wave propagation, among other things, is of great importance. O. H. Gish of the Department of Terrestrial Magnetism, Carnegie Institution of Washington, has designed equipment for continuously recording the electrical air conductivity as the balloon ascends into the stratosphere. Again, electronics plays a vital part in the functioning of this equipment, thus providing a degree of control and flexibility not realized in other devices heretofore used for such measurements.

The apparatus employs a hollow cylindrical air-flow tube with a small insulated rod located centrally along the axis of the cylinder. External to the air-flow tube is a shielded electroscopium comprising a parent plate and a platinized quartz fiber attached together at one end and connected electrically to the small rod in the air-flow tube. A second plate in the electroscopium, on the other side of the fiber from the parent plate, is charged positively by a battery. The small rod in the air-flow tube is initially charged to the same voltage, the outer cylinder and the shielding case of the electroscopium being grounded. Upon the flow of air through the air-flow tube, nega-

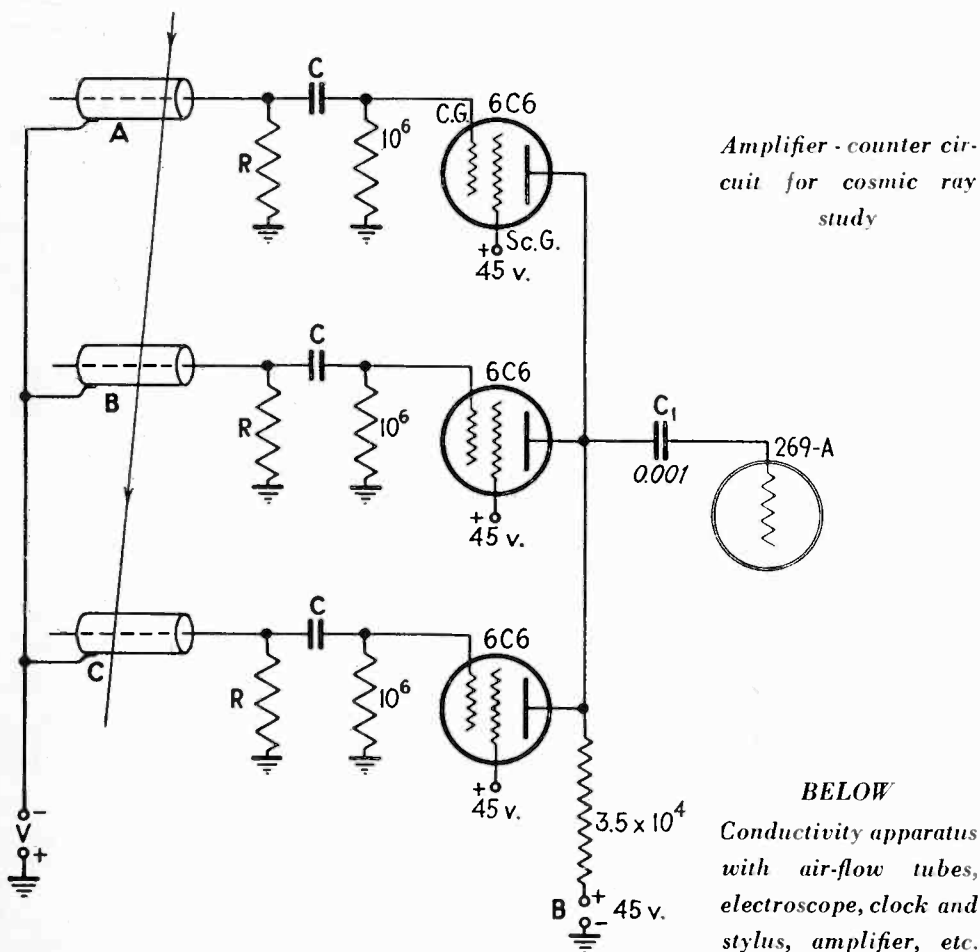

three counter units without passing through the sensitive angle of the telescope. Comparison of the results obtained with the shielded telescopes with those of the un-shielded ones should show to what extent sprays of cosmic-ray particles are prevalent.

The ultimate recorders of the telescope impulses are in duplicate. This was done partly as a precaution against failure of one set of recorders, and partly to gain additional information. The recorders, designed by Dr. W. F. G. Swann and Mr. Oscar Steiner, consisted of: (A) a set of 10 electro-mechanical dial-recording impulse counters, photographed at half-minute intervals by an automatic camera, and, (B) a set of 11 oscillographic units, which give a continuous record of the impulses, and the time-mark from Captain

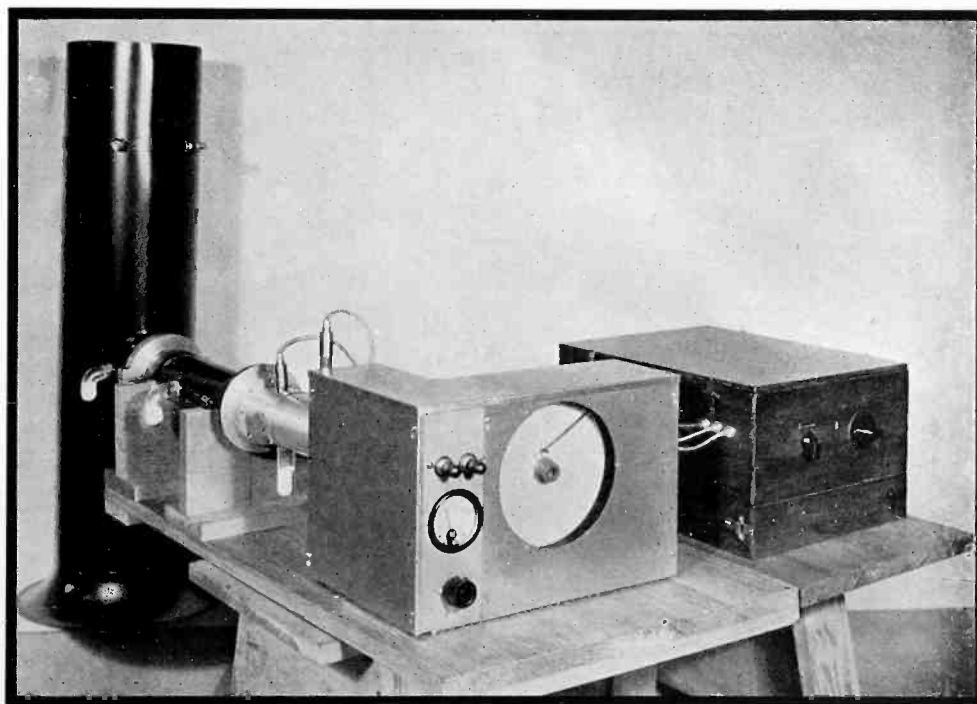

tive ions are attracted to the inner rod reducing the positive charge on it. The fiber in the electroscope then recedes from the parent plate in proportion to the rate of accumulation of negative ions on the inner rod, until finally the fiber touches the auxiliary positively-charged plate in the electroscope, when the inner rod of the air-flow tube is again charged positively. This process is repeated again and again, each contact of the fiber with the auxiliary plate passing on, by electrostatic coupling, a pulse to the grid of an amplifier. The amplified pulse in turn actuates an electromagnetic stylus. The latter records on a rotating disk the contacts between the fiber and the charging plate. The air conductivity is directly proportional to the frequency of contacts. The proportionality factor depends upon the capacitance of the electrostatic system (insulated rod and connections), upon the conductance-factor of the rod, upon the initial potential of the rod and also upon its final potential, namely, that just before recharging occurs. The initial potential may be made to differ from that of the auxiliary charging plate by the action of a charging electromagnet whose action is controlled by the same impulse which actuates the electromagnetic stylus. By this means the sensitivity may be readily varied by fifty fold.

If desired, the polarity of the battery charging the auxiliary plate of the electroscope may be reversed, in which case the inner plate of the air-flow tube attracts positive ions and the air conductivity corresponds to the rate of accumulation of positive ions on this plate. The important insulators are provided with guard-rings which may be maintained at a potential intermediate between the initial and final potentials and thus minimize loss of charge by other paths than across the stream of air in the air-flow tube.

The flight of the Stratosphere balloon, on November 11, 1935, afforded to radio listeners in general and to short wave fans in particular the opportunity of hearing a most unusual and interesting series of broadcasts. Those who followed the flight on the radio heard the whirr and clatter of the many scientific instruments in the gondola heard talk between balloon and ground.

This epic in radio broadcasting was made technically possible by the coordinated efforts of engineers in the RCA Manufacturing Co., RCA Communications, and the National Broadcasting Company. The heart of the whole broadcast — the radio equipment in the Stratosphere balloon—consisted of a low-powered transmitter operating on approximately 23 meters and a sensitive superheterodyne receiver. Both units were designed to be as economical of power as possible and both were entirely battery operated. Batteries for the receiver, because of their smaller size and weight, were kept inside the gondola. All other batteries were placed in thermally insulated boxes and so arranged on the outside of the gondola that they could be dropped as ballast.

The small radio transmitter bearing the call letters W10XFH contained 7 vacuum tubes; four operating at radio frequency and three at audio. Tourmaline crystals, one in service and one as a spare, were used to maintain the carrier frequency at the assigned value of 13050 kc. A 79 tube as a Class B modulator supplied the necessary eight watts of voice energy to modulate the final stage. An output to the antenna of eight to ten watts was obtained.

To provide communication from

the ground to the balloon during flight, a two-way telephone line technically known as "full period 813," but commonly referred to as the full talk circuit, was provided between all persons and points concerned. To this circuit were connected three short wave transmitting stations so located geographically as to be capable of reaching the balloon no matter how far or in what direction it went. It was through the medium of this special system of short wave stations—W3XL, Bound Brook; W9XF, Chicago; and W10XF, Rapid City—that many listeners on short wave heard communications between the National Geographic Society in Washington, the NBC in New York and Chicago, the flight base in the Strato-Bowl and the balloon.

To assure reception of the balloon signals under all possible conditions, approximately thirty receiving points were specially established by the National Broadcasting Company and associated network stations. Excellent cooperation in this work was also received from the Federal Communications Commission monitoring station at Grand Island, Nebraska. This point was regarded as particularly important, since it was close to the expected path of the balloon and

[Please turn to page 38]



National Geographic Society photo

Dr. Lyman J. Briggs of the Bureau of Standards and Dr. Swann of Bartol Foundation who holds a sensitive electroscope for cosmic ray study

Views and Reviews

BOOKS for the shelves of engineers and technicians in the electronics field. *Industrial Electronics, Communication Networks, and A Fugue in Cycles and Bels.*

Industrial Electronics

BY F. H. GULLIKSEN and E. H. VEDDER. *John Wiley & Sons, Inc., New York, 1935. (245 pages, 245 illustrations. Price, \$3.50.)*

THIS BOOK describes most of the important types of industrial applications in which electron devices are now being used. One equipment representative of each type of application is described in detail. The book is aimed at engineers who want to know ways in which electron tubes can be put to work for them, and to students in organized courses on industrial electronic apparatus.

In structure, the book is divided into four parts. Part I has three chapters, one on light-sensitive tubes and cells; one on high-vacuum tubes including cathode-ray and X-ray tubes, and a third on gas-filled tubes in which grid-controlled rectifiers as well as two-element rectifiers are discussed.

Part II deals with fundamental electronic circuits, Part III on electronic instruments and control devices, such as lighting control, door openers, sorting, grading, matching, color matchers, light intensity meters, followed by rectification and frequency conversion, welding control, relays. Part IV is devoted to electronic regulators such as voltage, temperature, speed, process and register regulation with many references to the literature.

The book is well illustrated. It is written in a straight-forward manner. If the authors seem to be partial to Westinghouse equipment it is only because they are most familiar with apparatus of this company. Both are members of the Westinghouse engineering staff.

Communication Networks, Vol. II

BY ERNST A. GUILLEMIN, *Assistant Professor of Electrical Engineering, Massachusetts Institute of Technology. The classical theory of long lines, filters and related networks. John Wiley & Sons, Inc., New York City. (587 pages; price \$7.50.)*

THE LONG AWAITED Volume II of Guillemin's Communication Networks has at last made its appearance. To those familiar with the first volume, little

need be said about the second except that it carries on the good work to a logical conclusion. The same clarity of presentation and style characterize the new book.

As the title implies, the book covers a very wide field. The first three chapters are devoted to the elementary concepts of the long-line problem, in which the steady-state solution is derived, and the concepts of propagation function and characteristic impedance developed. The transient behavior of long lines, which logically follows the steady-state solution is deferred until the end of the book, apparently because of the complexity of the subject and also because it is not necessary to an understanding of the intervening material.

Beginning with Chapter IV the characteristics of four terminal networks are presented, including the development of matrix algebra, which is extremely useful in solving problems in this field. Chapter V is an especially well-written presentation of the theorems of driving-point impedances. The transformations possible between linear networks are treated in Chapter VI and the use of matrix algebra in this work is clearly outlined, following which the effects of lumped loading on lines is described. Chapter VIII gives the practical approach to filter structures having recurring elements, thus leading to a consideration of conventional filter theory, in which the constant- k and m -derived types familiar to all workers in this field are introduced. It is made clear that the practical approach to this problem is essentially a cut-and-try process, and the more straightforward methods devoted by Cauer and Bode are then introduced in the next chapter, Chapter XII on simulative and corrective networks presents an approach to this problem almost entirely original with Professor Guillemin, and is of considerable interest as a new contribution to the art.

It must be remembered that the book is an advanced text, and not a design handbook. For this reason many concepts which may appear to be useless to the practical man have been introduced in order to acquaint the student with the philosophy of the subject. But aside from its great value as a text, the book should be welcomed by practical filter men for several reasons, among which are the fact that it is the first complete presentation of the lattice type method of filter design to appear in any book; second, because of the compact and well-written presentation of conventional filter theory which is included in Chapter IX; third, because of the

original contribution to corrective network design which appears in Chapter XII; and fourth, because the transient behavior of long lines and filters which is becoming more important as filter requirements are made more difficult, is treated in the book.—D. G. F.

A Fugue in Cycles and Bels

BY JOHN MILLS, *Director of Publication of the Bell Telephone Laboratories. D. Van Nostrand Company, Inc., New York City. (264 pages; price \$3.)*

MUSIC IS OLD, electricity new, and radio even newer. This book by John Mills deals with what electricity, through the discovery of the electron, is doing and will do to the old art of music. A clear and interesting exposition of the mechanism of acoustics as applied to music through the radio and the talking motion picture, is the foundation of the book. In it the author makes clear that high fidelity technique has brought electrically transcribed music to nearly exact reproduction; and that the future offers definite opportunities to create different qualities in music.

Few except a handful of progressives, like Leopold Stokowski have gone into this matter exhaustively. Composers have ignored, or what is more likely, do not know what has been learned of the laws of acoustics through the electrical development of the telephone, radio, and talking picture. An old art like music is slow to realize that science can teach it something besides mechanical improvement. Whoever reads this book need have but little imagination to perceive that the knowledge already acquired opens up a path for an exalted expansion of musical effects,—effects the great composers may have dreamed of but which have hitherto been impossible to produce. Even "the music of the spheres" and "the morning stars sang together" may cease to be mere figures of speech. This growing knowledge of sound and sound reproduction is a challenge to the present day composer of artistic music.

Any student of music will enjoy reading "The Fugue in Cycles and Bels," while the professional musicians will do well to study what is outlined in so understandable and interesting a manner. The book is also valuable for the electronics engineer who views the subject from the opposite point of view, since it clarifies the relation of musical quality to the concepts of electric circuit theory.—HAROLD A. G. FINK.

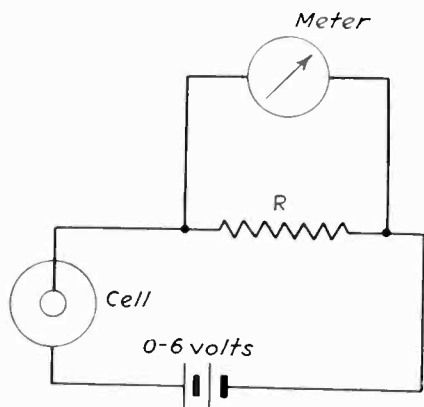
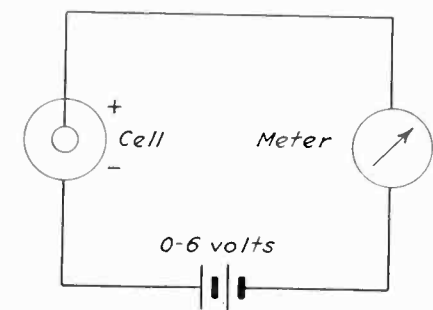

Fig. 1—Simple circuits using dry cells with light cells

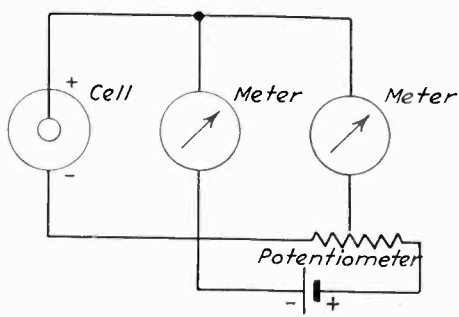

Fig. 2—Use of potentiometer to buck out dark current. *Journal of Scientific Instruments*, Apr., 1934, p. 125

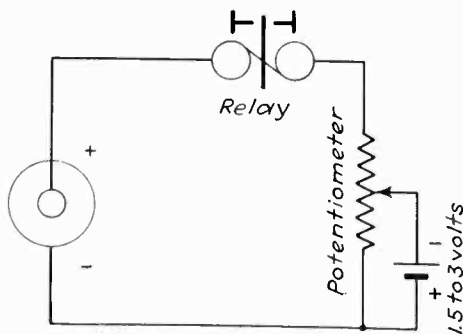

Fig. 3—Bias circuit to balance out dark current. Taken from "Die Lichtempfindliche Zelle" of H. Geffken, H. Richter and J. Winkelmann

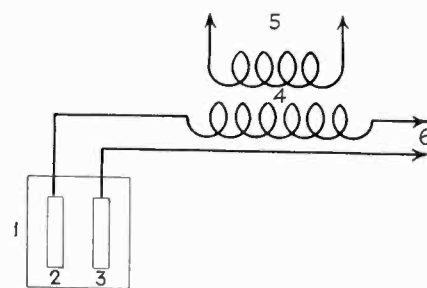

Fig. 4—Fessenden's patent 1,899,026 doing away with selenium inertia

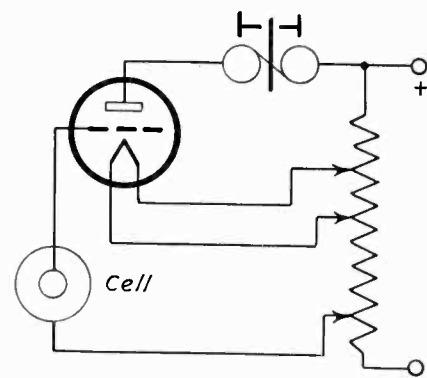

Fig. 5—Amplifying circuit of Geffken, Richter and Winkelmann

Light-sensitive Cell Circuits

Self-generating cells in series with applied potentials; methods of avoiding C bias; amplifiers for selenium and similar cells. Material collected by Mr. Samuel Wein, whose library on the photoelectric art is well known

GROWING interest and research into the possibilities of the self-generating type of light-sensitive cell, particularly in Germany, make it worth while to review methods of using these interesting devices. One of the difficulties in any review of the art lies in the fact that there is no universally adopted symbol for a self-generating cell. In the following data the German symbol will be used which gives the positive terminal as the inner electrode, the negative as the outer.

In the following discussion it is immaterial which type of cell is concerned, whether of the dry type consisting of a translucent film of metal depending upon contact potential between the metals to conduct the photo-potential, or the type on which a liquid conveys the photo-potential

between the electrodes. There are two general types as regards the materials used, selenium and cuprous oxide. Either will behave as a photo-conduction cell in which a resistance change occurs upon exposure to light.

Some work is being done with cells of these types when used in series with applied potentials. For example in Fig. 1 the cell is connected in series with an e.m.f. up to say 6 volts supplied by batteries. In Fig. 2 and 3 a bucking potential is utilized to balance out the "dark current" so that it will not interfere with the proper working of the circuit, or reading of an instrument.

In Fig. 4, the inertia period of a selenium cell is eliminated, according to R. A. Fessenden, the inventor (U. S. Patent 1, 899,026, Feb. 28, 1933). Here the selenium film is at

1 and the electrodes at 2 and 3, in this case composed of two pieces of copper wire one-half inch long and of about No. 22 B & S gage. Here the inventor claims a new discovery as follows. If a current of very high frequency (50,000 cycles is referred to in the patent) is connected to the circuit, its rate of flow will depend upon the capacity of the cell which varies with light intensity. But the flow of current will be much greater than if a d-c circuit is used, and there will be far less time lag (1/100,000 second or less). Fessenden states that such a circuit could be used for television purposes.

Amplifier Circuits

Various attempts have been made to amplify the voltage or current

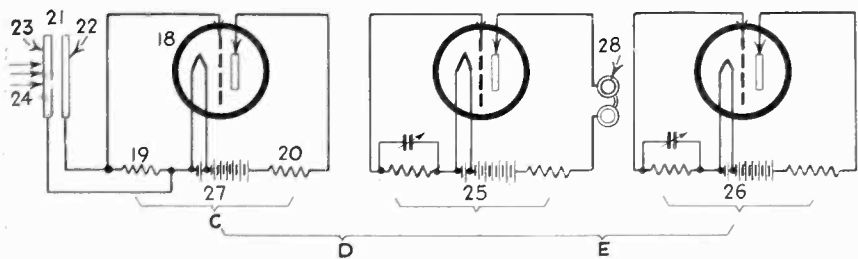

Fig. 6—Circuit using oscillating tubes. From E. C. Hanson and W. L. Carlson, U. S. Patent 1,437,240, Nov. 28, 1922

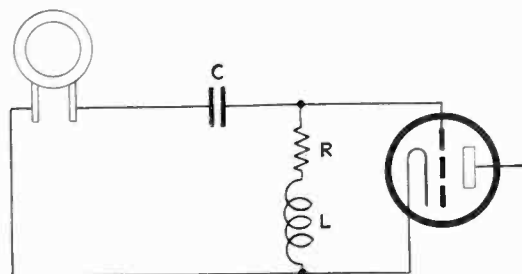

Fig. 8—A recent amplifier circuit from J. H. Roe, Review of Scientific Instruments, Vol. 5, p. 441, 1934

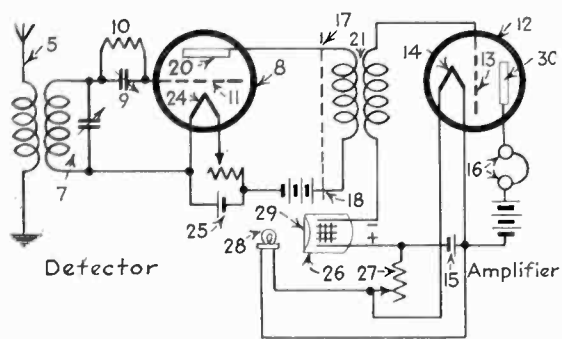

Fig. 7—Circuits to eliminate C bias in amplifiers. From W. T. Powell, U. S. Patent 1,678,077, July 24, 1928

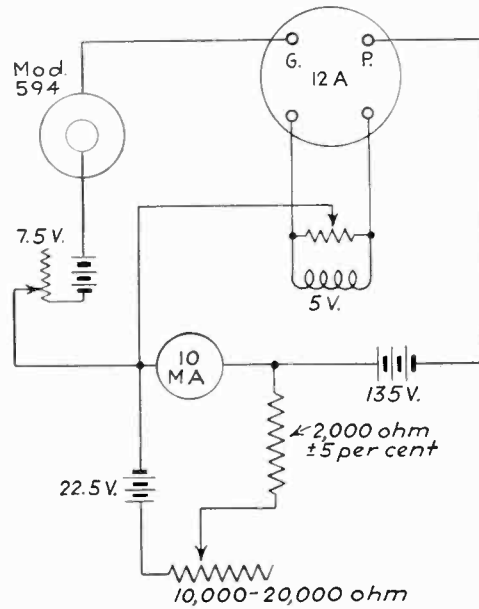
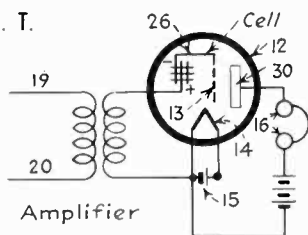
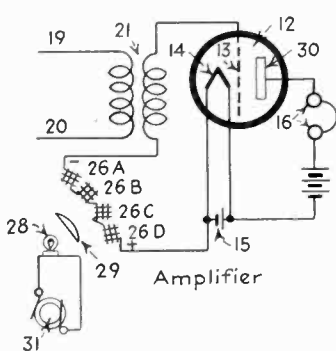

Fig. 9—Amplifier used with Weston cell. 20 foot candles will produce an output change of 150 microamperes

variations produced in the output of the self-generating type of cell. Figure 5 taken from Geffken and Richter's book *Lichtempfindliche Zelle* is a typical circuit. Those in Figs. 6 and 7 are taken from patent papers as indicated in the captions. They are probably tricky circuits but must be considered by anyone making a search of this art.

In Fig. 6 the vacuum tube 18 has its grid connected through the inductance 19 to the filament and its plate is connected to the filament through inductance 20. Inductance 19 is shunted by capacity 21, comprising a rigid plate 22 and a movable metal plate 23. A source of light falls on plate 23. Inductances 19 and 20 are magnetically coupled so as to sustain an oscillatory current. The tube circuits 25 and 26 are the equivalent of circuit 27. All these circuits are loosely coupled together. A suitable meter is inserted in the oscillating vacuum tube circuit 25.

The purpose of the circuit in Fig. 7 is to eliminate the C battery in an amplifier circuit. The cell 26 is illuminated by a source of light through a potential supplying the light source as at 15 and a variable resistance. The cell is connected in

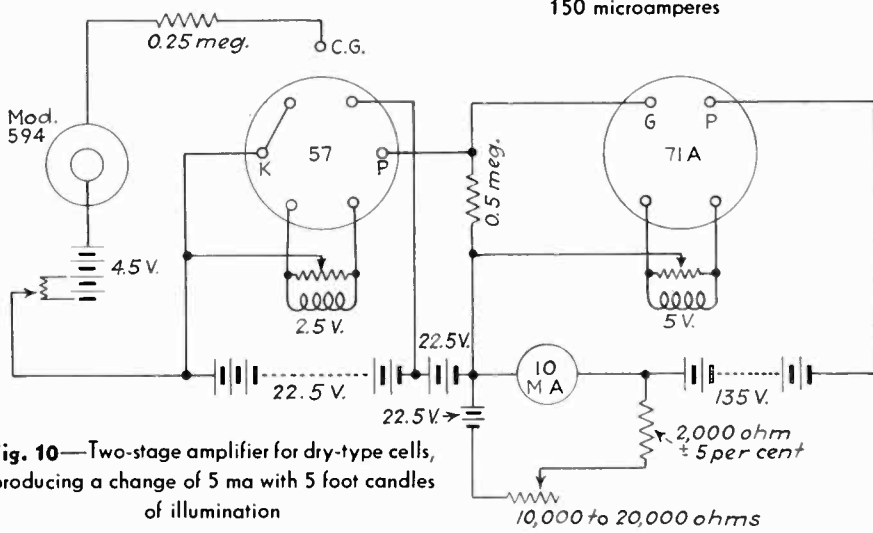

Fig. 10—Two-stage amplifier for dry-type cells, producing a change of 5 ma with 5 foot candles of illumination

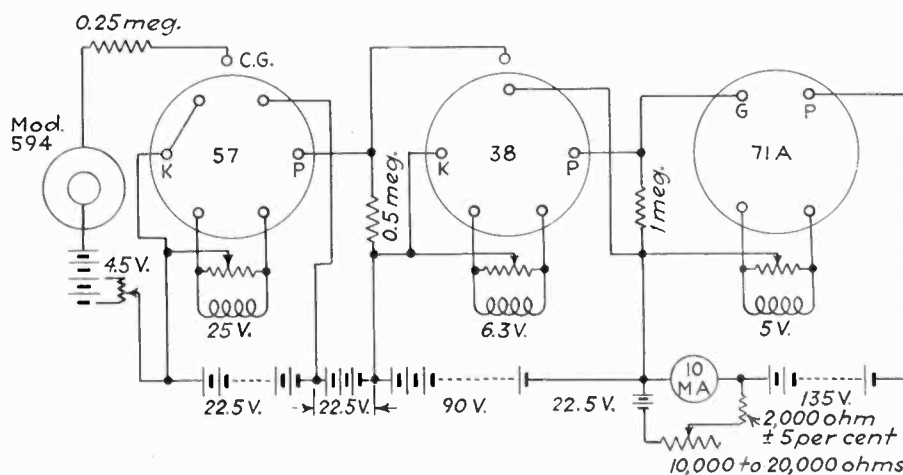

Fig. 11—Three-stage amplifier for Weston type of cell, one-half foot candle produces 10 milliamperes current change

series with the filament and the grid of the vacuum tube. In (b) the light source is fed from the current source which is separate from the filament potential. In (c) the cell inside of the vacuum tube, and the source of illumination emanating from the filament affects the cell with which it is a part.

A recent contribution in the use of these types of cells with amplifier circuits for audio frequency purposes is accredited to Roe. The circuit he recommends is seen in Fig. 8. The value of the capacity, resistance and inductance is a function of the frequency response desired. Below frequencies of 1,000 cycles, the capacity of C is 20 μ f.

The circuits in Figs. 9 to 11 are contributions of Weston engineers. They are arranged for the amplification of direct currents, and require continuous potentials and no condenser or chokes can be used. The heating of filaments may be by means of individually insulated transformers, although for stability storage batteries are recommended.

In general, the selection of tubes, resistors and voltages in these diagrams has been such as to give

the largest possible amplification with reasonable stability. A $\frac{1}{4}$ megohm resistance is shown in series with the cells; this reduces the gain but slightly since the tubes are voltage operated, and serves to safeguard the cell against discharges of various kinds, either due to the amplifier or to accident.

In Fig. 11, the three-stage amplifier has an overall mutual conductance of approximately 1,000,000 micromhos, giving a change of 1 milliamperes in the output circuit for a change of 1 millivolt input. Since it is extremely critical on input voltage, a potentiometer is shown across a dry cell for adjusting the initial grid voltage to bring the output current to a value of 3 or 4 milliamperes. This is most desirable since best results are had when working on the straight line portion of the tube characteristic. This should be done with buck-out circuit below the instrument disconnected; it may then be connected and the instrument or relay brought back to zero if this is required.

In this circuit particular care must be taken to solder, or otherwise make perfect all joints. The circuit will

usually need to be turned on one-half hour before use, in order to reach thermal and electrical equilibrium. Line voltage fluctuations on the filament transformers frequently results in drifting which can be eliminated by the use of storage batteries.

Who Invented What?

In connection with the growing interest in self-generating cells it is worth noting that the type of cell using selenium as the active surface, is known as the "Fritts cell," for it was he who has originally observed the effect in 1883. The cell as made by Fritts in 1883 is as good as those commonly available today on the open market by the few manufacturers making them.

The use of cuprous oxide as a light-sensitive material (photoconduction) is accredited to E. J. P. Mercadier of 1889. The effect was rediscovered by Prof. A. H. Pfund of Johns Hopkins University, and described by him 1916 and 1917. The original cell is in Mr. Wein's collection. This uses a film of gold on a film on a cuprous oxide slab. Grondahl and Geiger use a film of Cu_2O on a copper plate with a film of gold.

Electronics in Flight

[Continued from page 34]

did such excellent work in the flight of 1934. The NBC staff at the Strato-Camp established a receiving shack on the rim of the bowl. Signals picked up at this point were fed by wire line to the NBC control tent in the bowl, where they were put on both the full talk and broadcast circuits.

When the day for inflating the balloon finally arrived, fresh batteries and selected flight tubes were installed in all radio equipment. Final tests and adjustments were made to insure satisfactory operation. Work on the apparatus in the gondola was carried on in accordance with a prearranged time schedule allotting certain periods to each group.

At the proper point in the infla-

tion of the big bag, the support for the transmitting antenna was attached. The receiving aerial was rolled on a spool attached alongside the lower gondola port hole so that it could be conveniently lowered after the balloon left the ground. As soon as the bag was attached to the gondola, the transmitting antenna was pulled into place in the rigging and connected to the antenna bushings, W10XFH was then put on the air. A check from three receiving points, including RCA Communications stations at Point Reyes, California, and Riverhead, L. I., assured satisfactory signals even while the balloon was still in the bowl, shielded in all directions by 400 foot walls of rock.

The balloon left the ground at 7:01

AM MST and communication was established with Captain Stevens ten minutes later, as soon as he had lowered the receiving antenna.

Thus began one of the most interesting, unusual, and completely successful scientific ventures ever undertaken. Captain Stevens and Captain Anderson were at all times able to communicate not only with those at the Strato-Camp but with scientists and friends as far as Washington, D. C. Weather reports were given at frequent intervals to Captain Anderson. Both officers were able to report their progress to General Westover, Acting Chief of Air Corps, and as a fitting climax a journalist in London interviewed Captain Stevens as the balloon returned slowly to earth. In this flight radio achieved a new high, both in altitude and in public service.

EDITOR'S NOTE—In preparing this material the editors were aided by Drs. Swann, Locker, and Gish and by Mr. Robert Morris of NBC who was in charge of all broadcasting operations.



At left, the crystal cutter and heavily built lead screw necessary for aluminum engraving

Below, the mechanical filter in the turn-table drive consists of a spring-and-fly-wheel system

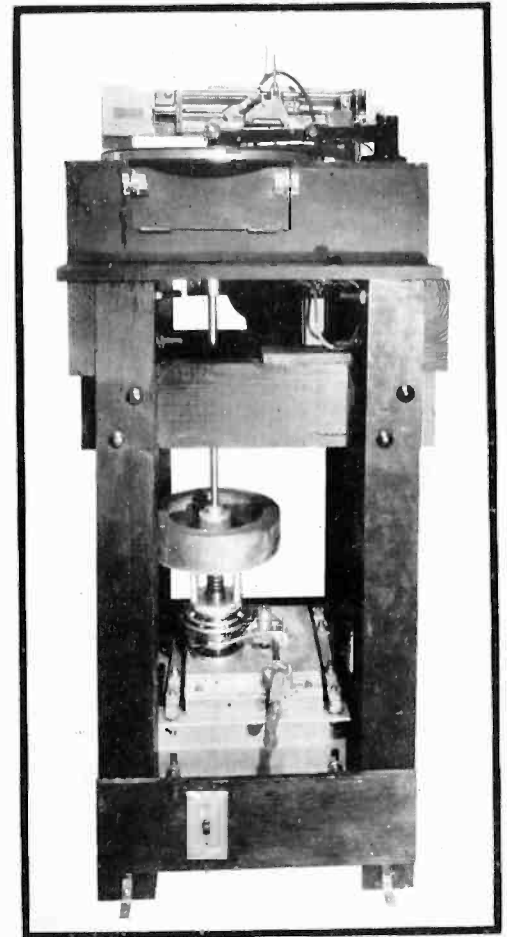

“Proof-Read” Recording

Engraving high-fidelity records directly on aluminum discs makes use of a three-watt piezo-crystal cutter, permits monitoring as the record is being made

IN all commercial recording for the production of duplicates in quantity, either on wax or on film, one of the insurmountable difficulties has been to secure an instantaneous check of the quality of the sound record, either while it is being made or immediately after it is completed. Monitoring a performance by ear phones connected to the recording amplifier, while helpful, does not check how the actual record will sound when it is played back. In disc recording, instantaneous monitoring of the actual record itself can be accomplished only when a pick-up can be placed in the groove immediately behind the cutter while the master record is being made, so that the actual reproduction can be monitored through a channel independent of the recording amplifier. This cannot be done on wax, without harming the master, and of course in the case of sound on film it is impossible. Thus in the two recording systems now available, no real check on the quality of the record is possible until the wax has been processed, and the first pressed record obtained—some twenty-four to forty-eight hours after the performance—or

until the film record has been developed and printed.

What this delay means in dollars and cents to producers of sound recordings, whether for radio, movie or sales talks, can be appreciated when it is considered that by far the largest item of cost in the production of a high grade studio recording is in the time of the highly paid artists or speakers who are engaged in the performance. Even these do not always perform without error, nor are they always properly placed with respect to the microphones. From a financial point of view it is important that the recording be “proof read” so to speak, before the expensive array of talent has left the studio, as the cost is doubled if they have to be reassembled on another day. If it can be done even while the record is being made—so much the better. This problem has been recognized by the production men in recording work much more than by the engineer, but the engineer must, of course, devise means for overcoming it. Metal master records have been proposed for this purpose.

Low quality recording on aluminum discs has been available for

home use for some time. For commercial recording, however, much better quality than this method permits is absolutely essential. Since the extremely high power which is necessary to engrave aluminum over a wide frequency band with a good frequency characteristic has not been available, current practice in aluminum recording has not merited much attention. However, certain aluminum alloys, properly finished with regard to surface and hardness, possess characteristics which have been found ideal for playback recording. The metal is soft enough to be engraved, and yet hard enough to be played back with a fibre needle without injury.

In a new process announced by Mr. B. A. Proctor of the B. A. Proctor Company, Inc. of New York, a piezo-electric crystal recorder has been used to engrave aluminum

master records over a frequency range of from approximately 40 to 10,000 cycles per second. The cutter itself, being of the crystal variety, is used with the proper compensating network to provide a flat response over this wide frequency band. The resulting master record may be played back during or immediately after recording without any injury to its characteristics either in frequency or amplitude.

Details of the System

The essential feature of this recording system is, of course, the cutting tool or recording unit. The crystal itself is a slab of Rochelle salt. Two polished metallic surfaces press against either side of this crystal. These surfaces are connected through a compensation network to the output of a 15-watt audio amplifier. The maximum power fed to the crystal during recording peaks is approximately three watts.

Attached to the crystal is the cutting tool, which consists of a specially shaped diamond, mounted in a steel shaft. The engraving head is mounted in an extremely heavy and rugged frame which is necessary because of the heavy forces which are set up in engraving metal. A blank metal disc is placed on the turntable and fastened solidly to it in the usual manner. The recording head is then lowered over the disc until the diamond makes contact with the aluminum surface and the recording is then begun. No particular care is required in this procedure, compared with the extreme caution required when using wax.

The recording, either while it is being made or immediately after, is played back over a high fidelity amplifier, using a crystal pick-up. When the master has passed the scrutiny of both the engineer and the production men, it is ready for duplication and pressed acetate records are produced for general use. A new duplication process has been developed to permit making copies within a few hours of the recording itself.

The extreme power which is available from the Rochelle salt crystal in the recording process is perhaps the most remarkable part of the development. To those who have had experience in the use of crystal struc-

tures it may seem inevitable that the crystal would crack when supplying three watts of power. No such trouble has been experienced, although some of the Proctor cutters have been in fairly constant use for over two years.

As a means of demonstrating the ability of the recorder to engrave frequencies as high as 10,000 cycles per second directly on metal, a crystal pick-up is caused to follow in the groove immediately after it has been engraved by the recorder. The output of this pickup is fed through amplifiers to a cathode ray oscillograph. The pick-up wave form can thus be compared directly with the wave form of the voltage fed to the recording mechanism. In such a demonstration, frequencies as high as 11,000 cycles per second have been observed in which the wave form was maintained accurately, although somewhat disturbed by the presence of surface noise inevitable at these high frequencies. Surface noise became a definite interfering factor at frequencies of 12,000 cycles per second and higher, but it was possible to trace through a microscope recordings as high as 14,000 cycles per

second. This is an ample margin over the requirements of high fidelity recording, when frequencies as high as 8,000 cycles per second are regarded as sufficient.

One feature of the Proctor system of record cutting accounts for the wide-range response when the records are played. It is that the diamond cutting stylus is maintained at a 19° angle, i.e. the same angle at which the play-back needle is set. In the wax system of lateral cutting, on the other hand, the cutting stylus has to be set within a few degrees of the vertical. The play back needle, to provide proper tracking, has to be set at approximately 20°. This discrepancy causes a definite loss in the high frequency response in the wax system.

Commercial development of the system is now under way. For such purposes the system has not only the play-back advantage, but also use of the metal master makes the system particularly adapted for recording at points distant from centers where processing and pressing is done, in that the masters can be shipped easily by mail without the extreme hazard entailed in the shipment of wax masters.

SOUND-EFFECT PICK-UP ELIMINATES NOISE GADGETS

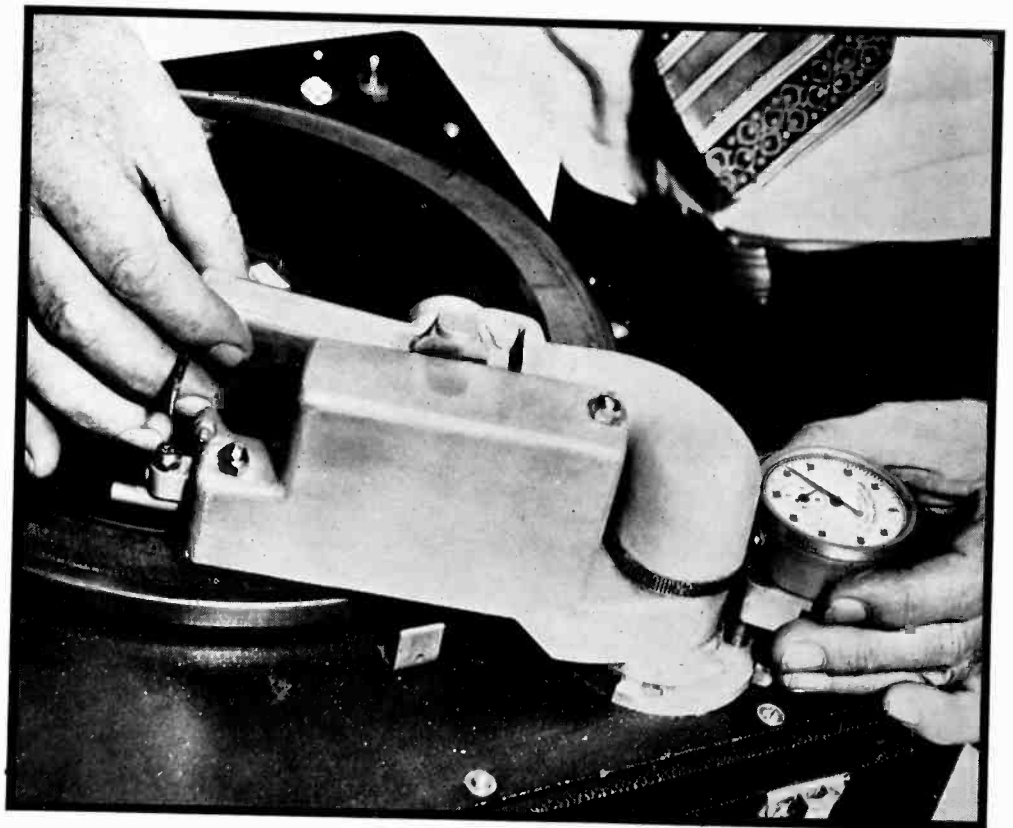

By pressing a button, this pickup is caused to select the desired sound effect from a record containing a wide variety of recorded noises. Accurate timing (note stopwatch) and precise mechanism permit selecting any individual groove on the record

1,000,000 megohms

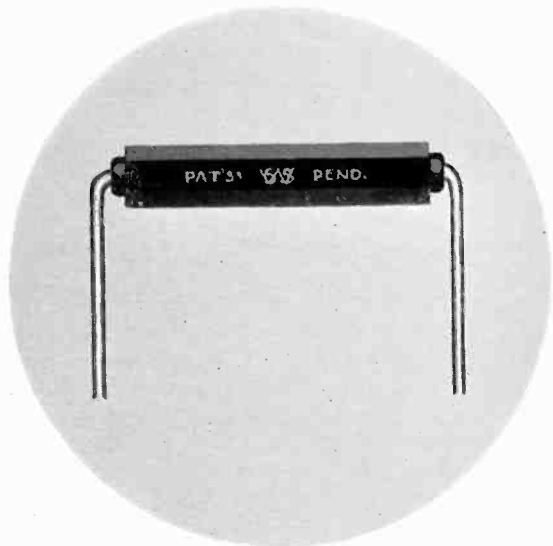

S. S. WHITE
MOLDED RESISTOR
TYPE 65X
(Actual Size)

This high value is available in the small S. S. WHITE Molded Resistor, Type 65X illustrated in actual size.

Type 65X is stocked in a comprehensive range of steps from 10 megohms to 1,000,000 megohms—all in the size shown.

Other S. S. WHITE Resistors of similar space-saving proportions are available in values ranging from 1,000 ohms to 10 megohms.

These Resistors meet every requirement of the Commercial, the Laboratory and Experimental fields. They are being used by many manufacturers of electronic equipment whose specifications are exacting. TRY them on your equipment—subject them to your own tests—and you will understand why.

The COUPON will bring you a circular showing the various types and giving capacities and prices. MAIL it—today.

The S. S. WHITE Dental Mfg. Co. INDUSTRIAL DIVISION

10 East 40th Street, ROOM 2310 E, New York, N. Y.

THE S. S. WHITE DENTAL MFG. CO. INDUSTRIAL DIVISION
10 EAST 40th ST. ROOM 2310 E, NEW YORK, N. Y.

DATE.....

Send me the Descriptive Circular
of S. S. WHITE MOLDED RESISTORS.

NAME.....
FIRM.....
ADDRESS.....
CITY.....STATE.....

THE ELECTRON ART

IN THE NEWS

DR. C. B. JOLLIFFE, who since 1930 has been chief engineer of the FRC and FCC has resigned his position, effective November 12, in order to accept an appointment as technical head of the



Dr. Jolliffe, snapped in a jovial mood at the Rochester I. R. E. Convention by Les Woods of Philco

Radio Corporation of America. The new position carries with it responsibility for the broad technical policies of the RCA organization, including allocations and technical handling of applications, and international conferences. Dr. Jolliffe is now located in the New York Offices, 66 Broad Street.

THE LATEST ESTIMATE has it that there are 2,295,770 homes in the United States owning two or more radios, that is, more than 10 per cent of all the homes equipped with radio facilities.

THE NEW YORK Y.M.C.A. Technical School has recently inaugurated a course in Applied Electronics which is being offered both during the day as a full time course occupying one year, and also at night, three evenings a week for two years. The course covers fundamentals of mathematical and physical theory before presenting practical tube applications in radio, communication and industrial fields.

THE LATEST WRINKLE in the broadcast station field is the use of goldfish in the water-cooling system of a large British broadcast station at Droitwich.

Algae and other aqueous plants which grew in the piping and coolers of the water system are now removed by 144 denizens of the deep, who live in the water cooling system as official employees of the broadcast station. A mechanic who had the job of cleaning the pipes suggested the use of the gold fish.

ALSO FROM ENGLAND comes word of two unusual uses for microphones. In several shafts in a mid-country coal mine microphones have been installed to reveal the motion of rock which might eventually cause disastrous cave-ins and other accidents. The noise of the rock motion is amplified and actuates a relay which sounds a warning. Recently the lives of twelve miners were saved when a fault not detected by geologists was revealed by the microphone method, permitting evacuation of the mine before the break occurred. The other use refers to the field of art. A sensitive microphone has been used to detect the presence of wood worms in a wooden plate which a 15th. century artist used as the background for a painting highly valued by the artistic world. The officers of a London art institute suspected the presence of the worms, but were reluctant to take action until definite proof was available. The microphone readily revealed the presence of the parasite.

REALLOCATION of broadcast station frequency assignments becomes in-

creasingly imminent, according to unofficial reports from Washington. The engineering department of the FCC has recommended 25 super-power clear channels, each to have one 500 kw. station, together with higher power ratings for regional, semi-regional and city channels. Action on the proposal has been deferred until an unannounced date.

THE UNPRECEDENTED VOLUME of manufacture in the radio receiving industry which bids fair to make 1935 the all-time record year has also been felt in Great Britain, where a Manchester firm recently applied for permission to introduce over-time working, in which female workers would be employed two shifts a day.

A GERMAN NEWS-REEL theatre is about to open with television apparatus as part of its permanent equipment. The television apparatus will be used to reproduce news films sent from a central television station, as a supplement to a regular service from news film projected with regulation equipment.

TEN NEW RADIO beacon stations are to be established at lighthouses and lightships, according to the Lighthouse Service of the Department of Commerce. When this program is complete every lightship in the United States will have this equipment, with a total of 118 beacon stations in operation.

THE ENGINE ROOM OF AN AIR-LINER

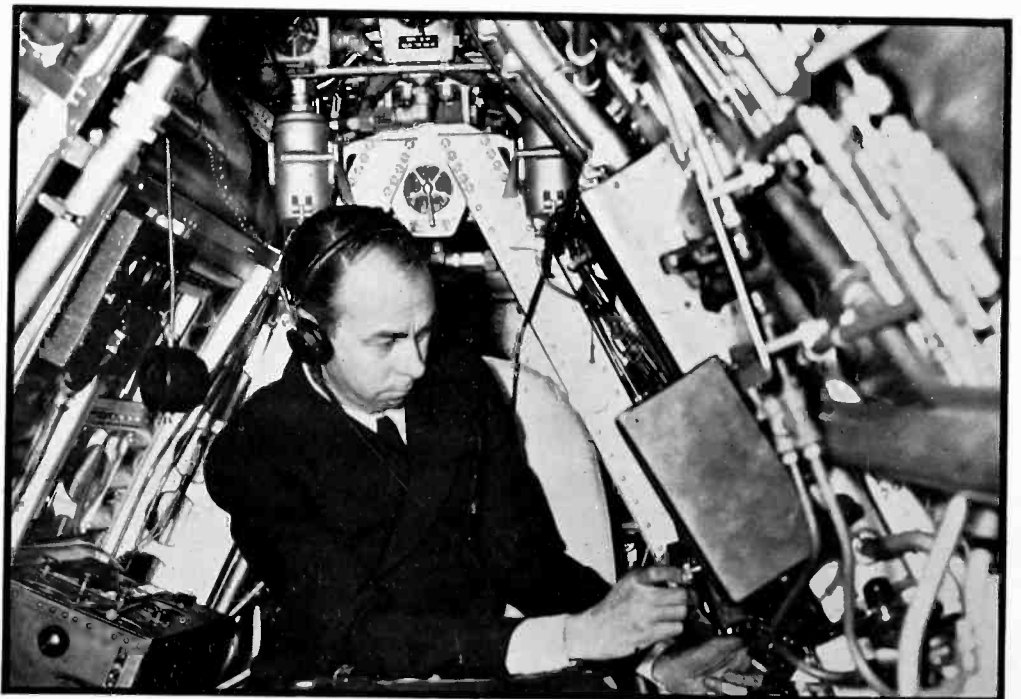

Chauncey Wright, engineer officer seated in the control room of the largest U. S. airplane the Pan-American "China Clipper". Complete radio equipment (note suspended microphone) is under his control

Photos by Wire—Sight without Eyes both aided by Bakelite Materials!

TODAY'S two most widely-known electronic devices—Wirephoto equipment and the "Electric Eye"—employ Bakelite Materials to insure accuracy and reliability in vital details of their construction. In these and many other delicate radio and electronic developments, the unusual and varied properties of Bakelite Materials have proved inestimably useful.

Specific properties and characteristics of Bakelite Molded which have caused its broad adoption by the industry are: high dielectric and insulation value; permanent accuracy of form; indifference to heat, cold and temperature change; and high resistance to moisture, oil and wear. In varying degrees, these same combined advantages are available also in Bakelite Laminated, Bakelite Varnishes and Cements and other Bakelite Materials now serving electronic science.

We are always glad to cooperate with radio and electronic engineers in selecting and applying the Bakelite Materials best suited to their immediate problems. For complete descriptions of the most widely applicable of these, write for our comprehensive booklets 13M, "Bakelite Molded", 13L, "Bakelite Laminated" and 13V, "Bakelite Varnish". Copies will be sent to you promptly on receipt of request.

BAKELITE CORPORATION, 247 Park Avenue, New York, N.Y. 43 East Ohio Street, Chicago, Ill.
BAKELITE CORPORATION OF CANADA, LIMITED, 163 Dufferin Street, Toronto, Ontario, Canada

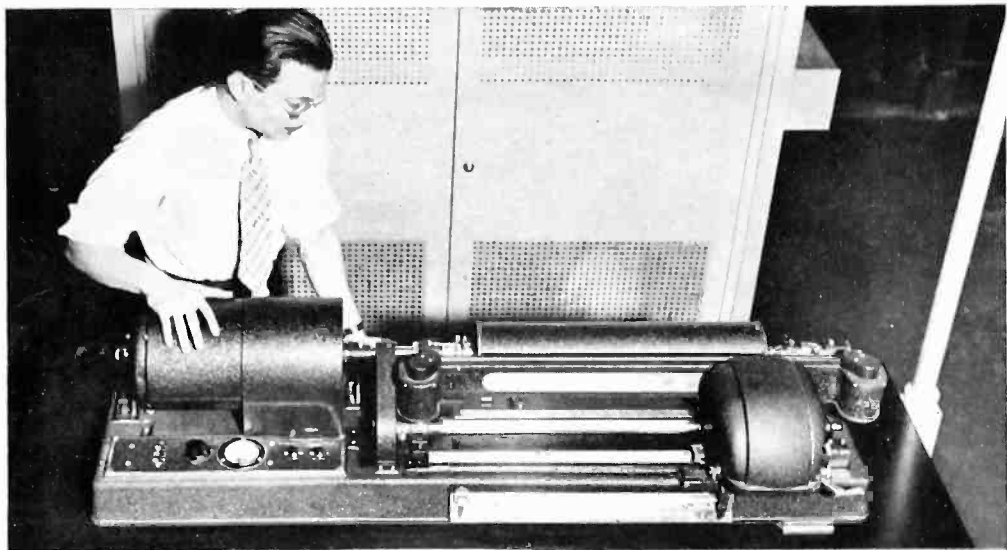

Above: The Associated Press Wirephoto Receiving Machine and some of the Bakelite Laminated Insulation parts used on the equipment.

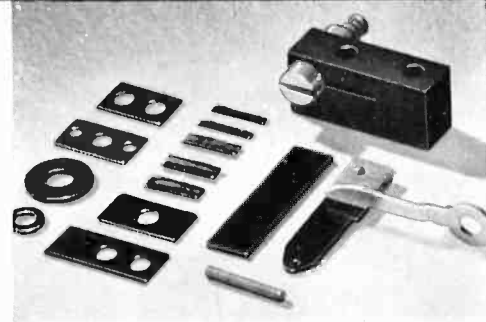

Below: Close-up interior view of the WLW "arc-extinguisher" lightning arrester, equipped with Weston Photoelectric Cell encased in Bakelite Molded.

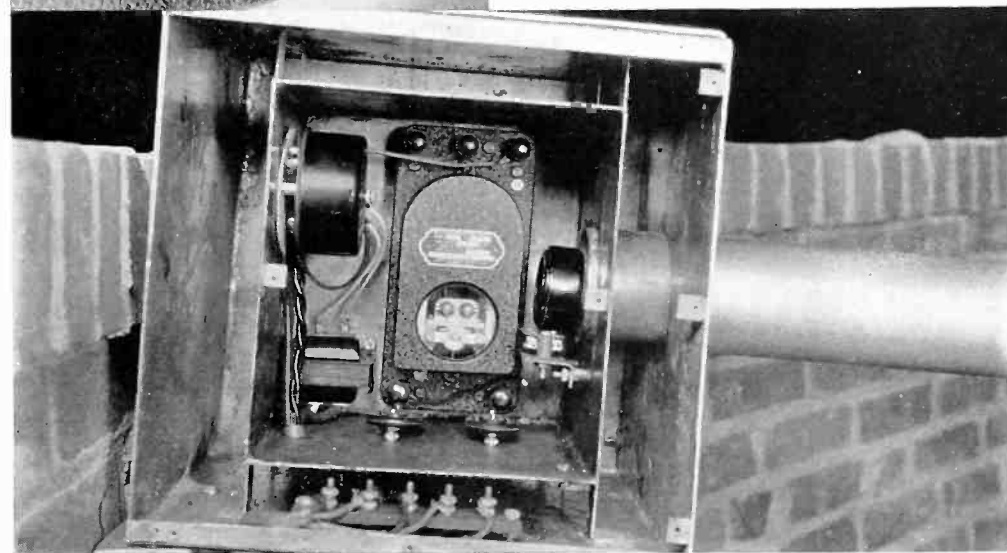

1910 — SILVER ANNIVERSARY — 1935

BAKELITE



The registered trade marks shown above distinguish materials manufactured by Bakelite Corporation. Under the control "B" is the numerical sign for infallible, or unlimited quantity. It symbolizes the infinite number of present and future uses of Bakelite Corporation's products.

THE MATERIAL OF A THOUSAND USES

ACCORDING TO THE LATEST tabulation issued by the United States Department of Commerce, there are 56,221,784 radio receiving sets in the entire world, of which 26,000,000 are in North America, and 25,000,000 in the United States. Of the 22,000,000 in Europe, 7,000,000 are in England, 6,000,000 in Germany and nearly 3,000,000 in France.

IN THE FIRST nine months of 1935 only five manufacturers of radio receiving sets went into bankruptcy, with a total liability of \$133,000. This compares with forty manufacturers who failed in the year 1930, with liability of \$3,522,000.

ACCORDING TO the *Daily Mail* of London, Professor E. V. Appleton, chairman of the British National Committee for Radio Telegraphy, has discovered a vast layer of intense heat above the upper atmosphere of the earth. This layer, Professor Appleton declares, accounts for the non-reflecting properties of ultra-short waves, limiting their range to optical distances.

NOTWITHSTANDING the fact that the United States is considered to be self-sufficient in so far as radio manufacturing is concerned, the Foreign Trade Statistics Report of the Department of Commerce indicates that from 2 to 5 per cent of the imports of all electrical apparatus and supplies each month is taken up by radio and wireless apparatus and parts.

THE CHAMBER OF COMMERCE of a New Jersey town has written to four of the leading broadcast stations in the New York area asking that the announcers of the station ask each evening at 11 o'clock that the receivers be turned low for the benefit of the neighbors who are retiring for the night. The broadcast stations are still pondering the idea.

WHEN THE RADIO SETS in a section of New York's Harlem suddenly became silent, servicemen were at a loss to account for the trouble until a policeman apprehended one James Cabey, a 17-year-old negro who had been cutting down aerials for the purpose of selling them to the junkman.

AS AN EXPERIMENT in the control of traffic, the New York Police Department recently broadcast from a blimp through station WINS. An observer in the blimp pointed out the least crowded highways leading to the city. Autos equipped with radio sets were thus enabled to avoid the most crowded roads, simply by tuning in on the broadcast.

Program of New German Tubes

[E. SCHWANDT.] After a truce of one year the entire inventory of receiver tubes is put on a new basis. It comprises 30 modified, if not new, tubes and a few tubes for special purposes. The starting point is to create tubes which have exactly the same properties whether they are heated by a.c. (Series A, 4 volts), or d.c. (2 volts, Series K and 6.3 volts, Series E for car-receivers) or whether they can be heated by both a.c. or d.c. (200 ma., Series C, or 55 volts for Series V for the national receiver). Gaps remain, of course; the K series and two other directly heated tubes differ from the other sets. With the exception of the battery tubes the new series of tubes is characterized by the smaller energy required for heating, 2.5 watts in place of 4 watts, their smaller size and their pinless base. The reduction of the heat supplied was made necessary by the smaller dimensions of the electrode system and the risk of heating the closest grid and the plate.

	4 volt, a.c. 0.65 to 1.1 amp.	200 ma. (13-30 volts)	6.3 volt, d.c.	55 volt a.c. d.c.	2 volt d.c.
Duo-diode...	AB2	CB2	EB1	KB1
Duo-diode- triode....	ABC1	CBC1
Triode....	AC2	CC2	EC2	VC1
R-f pentode	AF7	CF7	EF1	KF7
R-f expon. pentode...	AF3	CF3	EF2	KF8
Hexode....	AH1	CH1	EH1
Octode....	AK2	CK1	EK1	KK2
Output pen- tode....	AL1	CL1	EL1	VL1	KL2

In the new duo-diodes the screening between the two plates has been abandoned. The duo-diode-triode is intended for a.c.-d.c. receivers working from 110 volts. The new triode is less micro-

phonic than the older types. The exponential r-f pentodes had forerunners built for the export requiring 55 volts for a variation of the mutual conductance in the ratio 1:900; the new tubes are made for a variation of 1:400, which they produce with 20 volts. When larger changes are required the hexode is resorted to; this tube is used together with the triode for the mixing stage in superheterodynes. The octode is now built for a.c., a.c. and d.c., 13 volts d.c. and 2 volts d.c. because it has proved to be of great advantage for short-wave reception. Its internal resistance in the normal operating point is 1 meg., it gives 0.6 ma. per volt in the mixing stage for an oscillator voltage of 8.5.—*Funkt. Monatsh.* No. 8: 291-298. 1935.

Radio Research in 1934

THE FOLLOWING data are taken from a report by R. A. Watson Watt, Superintendent of the Radio Department of the National Physical Laboratory at Teddington.

A summary of the existing knowledge on constant frequency oscillators, published at the end of 1933 as Radio Research Special Report No. 13, 156 pp., Brit. Library of Information, 270 Madison Ave., New York, has dealt with the theory of oscillators as far as parameters of the tube may be considered as independent of the amplitude. In order to gain a more detailed knowledge of the chief causes of frequency variations other influences have since been examined. In the first place, a study of 11 tubes of different types has shown that as the emission current increases, the input capacitance of the tube increases until a limiting value is

OUTPUT STAGE PROVIDES 16 KW. ON 43 MC.

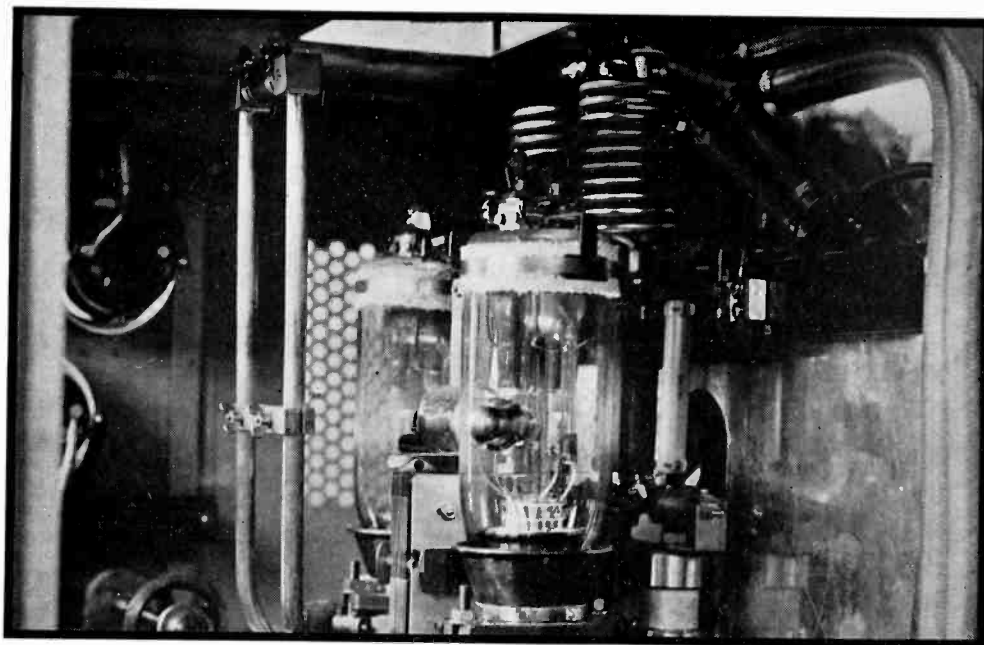

These two water-cooled tubes are the 20 kw. final amplifiers used for transmission of television and sound images in Germany, on a wavelength of 6.9 meters. According to reports in British magazines, signals from this transmitter have been heard in New York and Buenos Aires

the COLLINS 20C HIGH FIDELITY

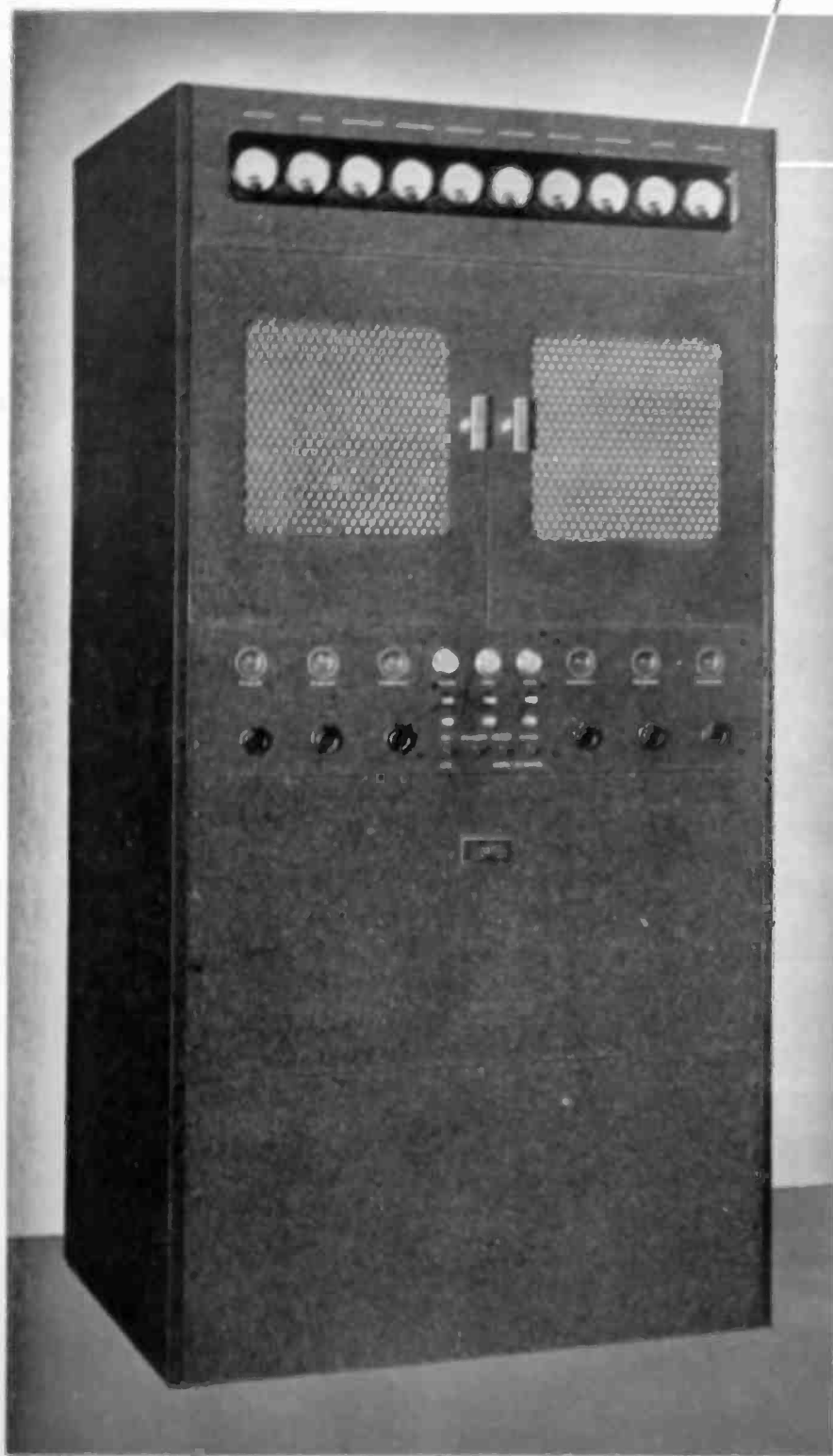

ONE-KILOWATT TRANSMITTER

★ ★ ★ **C**OLLINS broadcast equipment has established a unique reputation for faithful transmission. The frequency response of the 20C is uniform within plus or minus 1.5 decibels from 30 to 10,000 c. p. s. Total r. m. s. harmonic content is less than 5 per cent of the fundamental at 95 per cent modulation. Carrier noise is held 60 decibels (90 decibels weighted value) below program level by generous circuit design and without resorting to "hum bucking."

All components are over-sized and adequately protected by overload devices. The use of the very best materials and the most skillful mechanical design gives a fine appearance inside and out.

Every type of transmitting apparatus is manufactured by the Collins Radio Company. Microphones — Series 12 Speech Input Systems — Studio Accessories — Concentric Transmission Lines — Tower Impedance Matching Units — every component from microphone to antenna is co-ordinated for best performance. ★ ★ ★

COLLINS RADIO COMPANY

CEDAR RAPIDS, IOWA



NEW YORK, 11 West Forty-Second Street

SHIP FACSIMILE



Apparatus to be used on passenger liners for receiving weather maps and newspapers by facsimile

reached. The increase is larger with filaments of thoriated tungsten than with oxide-coated emitters which are operated at a lower temperature. In the second place the performance of two transmitters of moderate power has been followed. From the instant of switching on, the frequency drifts in the course of the first two hours, the shift reaching between 500 and 1500 parts in a million in the first transmitter and between 2000 and 4000 parts in a million in the second transmitter. The rate of frequency drift follows the rate of temperature rise of the inductance coil, the voltage being responsible for but 5 to 20 parts in a million. The measured temperature coefficient of coils wound on formers is greater than that of the conductor, the coefficient of self-supporting coils often less than that of the metal itself, showing that internal stresses play a part. Coils having a low temperature coefficient should be made of straight annealed rods only, on a former consisting of a substance free from gradual changes with time. Brass, steel and marble can be employed. One end of each component brass rod is free to slide through a brass block fastened to the marble. The normal expansion of the marble is compensated by making use of the difference in expansion between marble and steel, the pieces of steel controlling the turn spacing. A coil of 2.1 mh built in this fashion changes by less than one part in a million for 1° C.

Short-wave oscillators—Experiments on the production of ultra-short waves by inverted diodes (Kurz-Barkhausen oscillators), consisting of a central plate surrounded by four or more tungsten filaments arranged in parallel, have shown that the efficiency increases with increase in the number of filaments and decreases with increased temperature of the filament.

The hypothesis that this type of oscillator consists of a dance of the electrons about the plate and the filament is thus disproved. The relation between wave-length l and voltage V is represented by $lV^2 = \text{constant}$. The negative resistance condition necessary for the generation of oscillators is produced by the direct travel of the electrons between the electrodes. Maximum efficiency may be expected from an inverted diode in which the cathode is a full cylinder and indirectly heated.

Atmospherics—The three-stage resistance-capacitance amplifiers with a total gain of 60 db for recording atmospherics have been further improved. Their characteristic is flat from the very lowest frequencies (less than 20 cycles) to about 5 kc and drops by about 2 db toward 30 kc. Since the components of the atmospheric at 10 kc are frequently 10 to 20 times as strong as the component at 1 kc, high frequency attenuation has been provided in the form of a 0.004 $\mu\text{f.}$ condenser to be inserted between the plate of the first tube and the ground. Atmospherics consist of two portions, one a slowly varying current lasting for a few milliseconds and an oscillating component corresponding to a frequency of 5 to 10 kv per sec. As the distance from the lightning discharge increases from a few miles toward 2000 miles, the two components become more and more separated. To explain the lag it is necessary to study the propagation of pulses of short duration in the ionosphere. Regular work on atmospherics will also be carried out by the U. S. Navy and the Universities of Porto Rico and Florida.

Propagation of radio waves—Recent automatic and half-automatic records representing soundings of the ionosphere at vertical incidence by means of waves in the range 1 to 6 Mc show that while during the night-time, the ionosphere is divided into two main regions, the lower of which is the Kennelly-Heaviside or E region, and the higher the Appleton or F region, there are formed in the day-time further zones of ionization. A layer more richly ionized than the E region (which has about 200,000 electrons per cc. at noon and 10,000 electrons at night) is often found between the E and F regions; another one forms a lower shelf on the F region. There are thus in a day-time two series of four critical frequencies, relating in succession to E_1 , the new E_2 , the new F_1 , and F_2 , one series associated with the ordinary and the other with the extraordinary ray of magneto-ionic dispersion.

The soundings carried out provide a measure of the ionization of the new regions E_2 and F_1 , during the daylight hours throughout the year in the latitude of England, a measure of the ionization of E_1 throughout the year at noon, and of the F_2 region during the night throughout the year. The heights of all the regions are measured at least once a day (see also T. R. Gilliland, *Journal Res. Nat. Bur. Stds.*, March, 1935).—*The National Physical Laboratory Report for the Year 1934.*

NOTE—A survey on the behavior of "Magnetic Materials at Radio Frequencies," by F. M. Colebrook of the Laboratory, has been published as Radio Research Special Report No. 14.

SIX CONTINENTS CONTACTED ON 28 MEGACYCLES



Miss Nellie Corry, G2YL, with her 10-meter amateur station in Surrey, England. Contacts with stations in six continents were established with this equipment in six hours and two minutes on 28 Mc, a frequency once thought to be "quasi-optical"



BE ON THE *LEE,* SIDE

»»» It pays to be a "fair-weather" sailor in the radio business. No use heading into a storm with parts that won't stand punishment.

Set manufacturers who use CENTRALAB RADIOHMS find clear sailing ahead, for these noiseless controls are built for smooth customer-satisfaction. Specify Centralab.

Manufacturers of Centralab Fixed Resistors

Centralab

Milwaukee, Wis.

Radiohm

MANUFACTURING REVIEW

Names in the News

♦ **Louis Gerard Pacent**, president of the Pacent Engineering Corp., New York City, has been appointed a member of the World Fair Committee which will formulate plans for the World Fair to be held in New York in 1939.

♦ **Frank K. Speidell** and **C. H. Bradford, Jr.**, were appointed vice-presidents of Audio Production, Inc., according to an announcement of the Board of Directors of that company. Mr. Speidell was formerly director of the Industrial Division, while Mr. Bradford was formerly treasurer.

♦ Several changes in the personnel of the Bruno Laboratories, New York, are announced. Mr. R. B. Fernald, formerly of the sales department of the Kenyon Company, has been appointed sales manager, to fill the position vacated by Mr. John Kopple. Mr. Paul von Kunits, formerly chief engineer of the General Broadcasting System has been appointed Chief Engineer of the Radio Division.

♦ **Joseph H. Beck** has been appointed production manager of Midwest Recordings, Inc., producers of electrical transcriptions for radio broadcasting. Mr. Beck has been associated with the scenario departments of several large motion picture companies and with advertising agencies in Chicago.

♦ **Samuel Bartlett** has been appointed production manager of the Otto K. Olesen Sound Studios, of Hollywood, California. Arthur Davis, formerly of Western Electric in Hollywood has joined the recording manufacturing division of the same company.

♦ **George L. Starr**, of Toronto, and **Gordon L. Elmslie**, of Montreal, have been appointed Canadian representatives for the sale of nickel, chrome, brass and copper coated sheets, manufactured by the American Nickeloid Co., Peru, Illinois.

Industry Notes

According to an announcement of Mr. Joseph D. R. Freed, president of the Freed Manufacturing Co., Inc., the factory, executive offices and sales offices of this organization have been moved to 44 West 18th St., New York City. The new plant will afford production facilities three times as great as the old.

Complete X-ray equipment for diffraction analysis of various materials has been installed by the St. John X-

ray Service, Inc., 30-20 Thomson Ave., Long Island City, N. Y. Instead of gas tubes, new special research tubes with molybdenum, copper and cobalt targets are now available for this work.

The first license under R.C.A. patents granted for manufacture of kit receivers has recently been issued to the Tobe Deutschmann Co., of Canton, Mass.

The Thwing Instrument Co., of Philadelphia, Pa., makers of commercial and laboratory measuring equipment announces that the company will henceforth be known as the Thwing-Albert Instrument Co. This change is in name only, since it involves no change in ownership, management, policy or product. Mr. Edward J. Albert has been manager of the company for the past 17 years.

Callite Products Co., 39th St., Union City, has recently added new equipment and enlarged their facilities for the production of tungsten and molybdenum products to take care of the increased demands of the radio tube industry.

The Harris-Green Co., Farmers Bank Bldg., Pittsburgh, Pa., has been appointed district sales agent for Western Pennsylvania, Eastern Ohio and West Virginia by the Roller-Smith Co., New York City.

Communications Engineering Company has incorporated under the name of Electronic Mechanics, Inc., at their new address 201-203 East 12th St., New York City.

New Products

Tubes

500-watt Tube. Eitel-McCullough, Inc., San Bruno, Calif., announce the Eimac 500T, a general purpose triode having 500-watt plate dissipation. When used for high level modulated radio telephone the power output is 500 watts. When used as a class C high efficiency amplifier power output is 1,350 watts. For class B radio frequency amplification output 250 watts. Plate voltage 4,000, maximum current 450 milliamperes. Filament $7\frac{1}{2}$ volts, 20 amperes. Amplification factor 15. Height $16\frac{1}{2}$ in.

Metal Tube Gas Rectifier. A new rectifier tube, type OZ4, developed by the Raytheon Manufacturing Co., of Newton, Mass. Mounted in a metal

shell, contains no filament, but operates with a cathode heated by ionic bombardment. Similar in principle to the Raytheon type BH tube. The list price is \$1.75. Will provide an output volt-



age of 300 at 75 milliamperes. Intended primarily for use in vibrator type B-supply units for automobile receivers. Contains an internal glass bulb to insulate the gas content from the grounded shell.

Metal duo-diode triode. Raytheon Mfg. Co., Newton, Mass., announces a duo-diode triode in the metal tube series corresponding closely to the type 75 glass tube. The amplification factor of the triode section is 70 with a

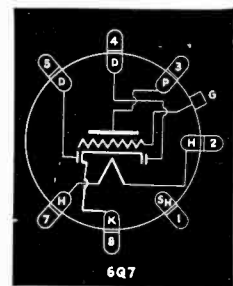

plate resistance of 59,000 ohms. Mutual conductance is 1,200 micromhos. Type 6Q7, similar in external appearance to the 6K7.

Components

New Carbon Resistor. A solid molded carbon resistor available in standard resistances from 100 ohms to 10 megohms and a power rating of $\frac{1}{3}$, $\frac{1}{2}$ and 1 watt, color coded, non-hygroscopic and non-inductive. Aerovox Corp., 70 Washington St., Brooklyn, N. Y.

Insulated Metallized Resistors. The International Resistance Co., of Philadelphia, Pa., announces a new line of low wattage resistors known as type B insulated metallized resistors. The units are similar to the type F metallized resistors but are coated with a high voltage insulating material. One

Step-Frequency Oscillator



THE TYPE 508-A OSCILLATOR is designed for bridge and communication-equipment measurements where continuous variation in frequency is not required.

This oscillator furnishes ten frequencies between 200 and 4,000 cycles, with an output of one-half watt in a 2,000-ohm load.

The instrument is a-c operated and has a frequency stability within 1% over considerable periods of time.

The two models stocked are:

Type 508-AM, Cabinet Mounting, \$120.00

Type 508-AR, Relay Rack Mounting, \$120.00

For Complete Details Write for Circular P-63-E

General Radio Company
Cambridge, Massachusetts

PERFECT
LAMICOID
REG. U. S. PAT. OFF.

Laminated Bakelite

Sheets, Tubes, Rods, Fabricated Parts

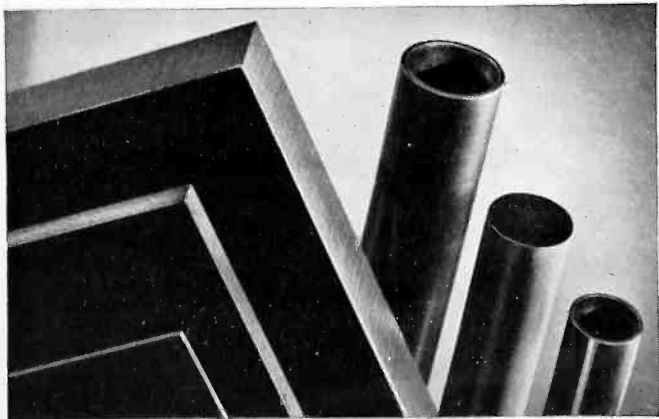

Made of the finest raw materials, including genuine Bakelite Resins. Uniformity of quality assured by use of the most advanced automatic control equipment. Write for complete information and prices.

MICA INSULATOR COMPANY

200 VARICK ST., NEW YORK; 542 South Dearborn St., Chicago; 1276 West Third St., Cleveland . . . Branches at Birmingham, Boston, Cincinnati, Los Angeles, San Francisco, Seattle. Canada: Montreal, Toronto.

a New Crystal Pick-up by

WEBSTER ELECTRIC



fitting companion
to the well-known
and widely-used
magnetic type . . .

● When the Webster Magnetic Type Pick-up was introduced to the field, its performance characteristics met the approval of the most critical.

The new Webster Crystal Pick-up is destined to receive the same enthusiastic approval.

For this new pick-up embodies the precise design, the engineering skill and the careful craftsmanship so essential to fine performance in sound reproduction apparatus.

The Webster engineers have applied a new adaption of theory in the design of this new pick-up which provides the very ultimate in high frequency response with a minimum of needle noise.

The Webster Crystal Pick-up has many design features—some of which are listed to the right. It is available for use with both standard and 16-inch records in both standard and high fidelity response.

Literature which describes it in detail will be mailed you upon request.

*Licensed under patents of
Brush Development Company*

WEBSTER ELECTRIC COMPANY

Established 1909

RACINE . . . WISCONSIN, U. S. A.

*Export Office
15 Laight St., New York City*

Wherever Sound **W** Must Fill Great Spaces

WEBSTER

ELECTRIC

FEATURES

- 1** Compact with light needle weight on record.
- 2** Free from resonance.
- 3** Lower scratch and distortion level.
- 4** Low mechanical needle point impedance.
- 5** Chatter Proof—wear-resisting mechanical construction.
- 6** Moulded-in screw terminals—no soldering required. (Avoids possible damage to crystal from heat.)
- 7** Double sealed against moisture.
- 8** Built-in volume control (or without).
- 9** Compensated frequency response (standard or high fidelity).
- 10** Range of voltage output up to 1.5 V. at 1000 cycles.

watt sizes are provided from 300 ohms to 10 megohms, while the ½ watt unit is available from 100 ohms to 5 megohms. Descriptive catalog available on request.

Iron-Core i-f Transformer. A new iron-core intermediate frequency transformer with duo-lateral coils has been announced by the J. W. Miller Co., of Los Angeles. The core is made of Crolite, a finely divided magnesium alloy imbedded in a ceramic body. Aluminum shields 1½ x 1½ x 3½ in. are provided. Twice the selectivity and gain of the air-core type are claimed for the iron-core transformers. List price \$2.00.

Octal socket: A wafer-type octal socket of unusual design, embodying high voltage break-down construction. Lugs are flared from center permitting easy wiring. Requires no rivets for



fastening to panel; is locked in position by turning in specially punched opening. Manufactured by the A. W. Franklin Mfg. Corp., 137 Varick St., New York City. Occupies 1¼ inch overall diameter space in chassis.

Vacuum Power Switch. The Continental Electric Co., 210 S. First St., St. Charles, Ill., announces two vacuum power switches, types VPS-1 and VPS-2, both single pole, single-contact switches normally opened and normally



closed respectively. Magnetically operated by solenoid, with contact ratings of 20 amp. at 110 volts, with a maximum speed of operation at full load of 100 contacts per minute. Sealed construction permits use in corrosive or inflammable atmospheres.

• • •

Audio Equipment

Output Switching Panel. A switching panel for speech input equipment designed by the Bell Telephone Laboratories is announced by the Western Electric Co., 195 Broadway, New York City. Provides facilities for dispatch-

ing programs from as many as six amplifier channels over four output circuits to line amplifiers. Described in Western Electric Bulletin "Output Switching Panel 271A."

Professional Recorder. A professional recording machine announced by the Universal Microphone Co., Inglewood, Calif. Weight 125 lb., turntable disk 16 in. in diameter, with rim drive. Driving motor is 100 per cent synchronous, 110 volts a.c. reversible, not self-starting. Countershaft permits 78 or 33½ r.p.m. recordings on 50 or 60 cycle current. Set standard for 108 lines

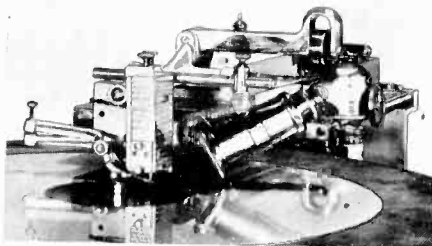

per inch, which can be changed as desired. Cutter contains four pole pieces and adjustable damping. Cobalt steel magnet.

Dynamic Speakers. Two new dynamic speakers of 5- and 6-in. diameter of careful design and good frequency



range are announced by the Ariston Manufacturing Corp., 4045 Diversey Ave., Chicago, Ill.

P. A. Attenuator. The Tech Laboratories of 703 Newark Ave., Jersey City, N. J., announce a new attenuator



specially designed for P. A. and portable equipment, listing at \$8. 2½ in. diameter by 1¼ in. deep, 22 steps of attenuation covering a range of 50 decibels. A bulletin describing the attenuator is available upon request.

Modulation Transformer. A variable impedance modulation transformer is announced by the Thordarson Electric Mfg. Co., 500 West Huron St., Chicago, Ill. Permits coupling 500 ohm

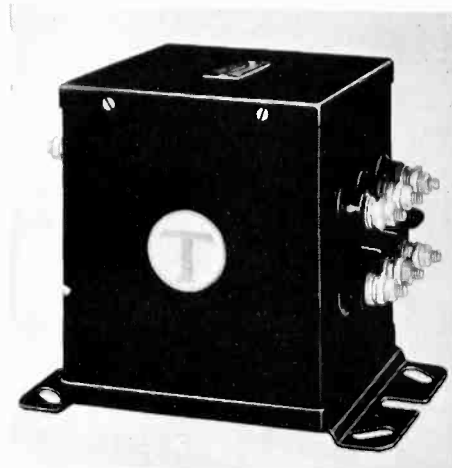

output of audio amplifier to any r-plate circuit, carrying not more than 250 milliamperes d.c. Will handle 80 watts of audio power. Audio characteristic essentially flat up to 7,000 cycles, Type No. T-7532. Weight 16½ lb.

• • •

Materials and Fittings

Dielectric Material. A molded plastic of especially high dielectric breakdown and dielectric fatigue characteristics. Known as material 2491, and available in black, brown and red. According to A.S.T.M. tests material has a dielectric breakdown of 550 V/M and a dielectric fatigue of 400 V/M/M. Manufactured by General Plastics, Inc., North Tonawanda, N. Y.

Fuse Post. A new extractor fuse post for the standard 3 AG fuse which extracts the blown fuse when the knob

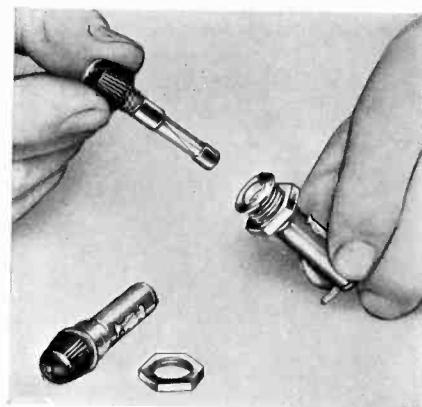

is unscrewed, announced by the Littelfuse Laboratories, 4238 Lincoln Ave., Chicago, Ill. Known as type 1069, ½ in. mounting hole, overall length 2¼ in., suitable for all loads of less than 5 amperes at 110 volts.

Fluorescent Materials. Two new television fluorescent compounds manufactured by the deHaen Company of Germany, and marketed in the U.S.A. by Pfaltz & Bauer, Inc., 300 Pearl St., New York. No. 194 gives black-white images with sharp contrasts. No. 148

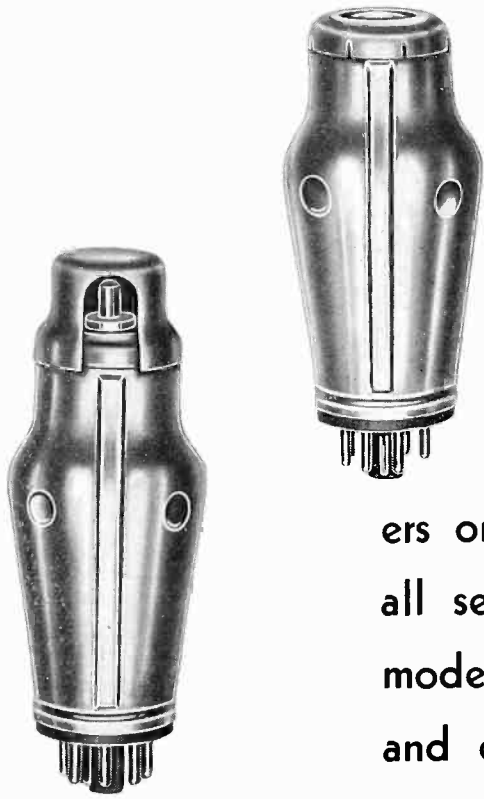

GOAT.... Form Fitting Tube Shields

Used by some set manufacturers on all of their models and by almost all set manufacturers on some of their models—for performance, appearance and economy.



GOAT RADIO TUBE PARTS, INC. • • • • • 314 Dean Street, BROOKLYN, N. Y.

(A Division of THE FRED GOAT COMPANY, INC., Established 1893)

43 Ohio Street, Chicago, Ill.

200 N. Edgemont Ave., Los Angeles, Calif.

500 King Street, West, Toronto, Canada

MACHINED PARTS
SHEETS—RODS—TUBES OF
DILECTO
LAMINATED PHENOLIC INSULATION

DIAMOND FIBRE
HARD VULCANIZED FIBRE
FOR high insulating Qualities, Great Mechanical Strength, Permanence, Resistance to Heat, Cold and Chemicals.

MICABOND
MICA IN ITS MOST USABLE FORM

CONTINENTAL DIAMOND FIBRE COMPANY
NEWARK DELAWARE
CHICAGO CLEVELAND NEW YORK

Outstanding Performance With the New Type 148 Cathode Ray Oscillograph

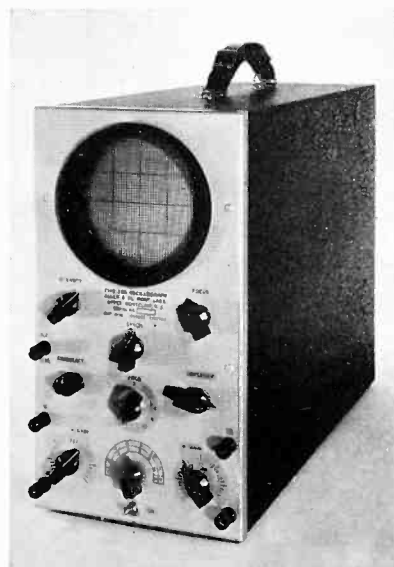

- **BASICALLY NEW SWEEP** allowing waves from 10 to 500,000 cycles per second to be observed with improved linearity and exceptionally fast return trace.

- **IMPROVED SYNCHRONIZING CIRCUIT** permitting locking sweep with fractions as well as multiples of wave.

List price with 3" tube.....\$91.50
List price with 5" tube.....\$106.50

- **CASCADE AMPLIFIER** giving 1 inch deflection with .2 volt signal.
- **SINGLE KNOB** controls all switching.
- **PATENTED CALIBRATED SCALE** with 5 Inch Du Mont cathode ray tube.
- **COMPLETELY AC** operated.

Write for complete specifications on this oscillograph.

ALLEN B. DU MONT LABORATORIES
UPPER MONTCLAIR, N. J.

has special brightness and light emission. Trial lots of both compounds are now available in this country. A spray pistol especially designed for the application of fluorescent compounds is also available.

Plier Set. A set of four 4½ in. pliers particularly designed for ignition, electrical and radio work has been announced by the K-D Manufacturing Co., of Lancaster, Pa. Made of special alloyed steel tempered for correct hardness and packed in a steel box.

Measuring Equipment

Cathode-Ray Equipment. Two new cathode-ray instruments are offered in the Clough-Brengle line at 1134 W. Austin Ave., Chicago, Ill. Model CRA



is complete with built-in linear sweep circuit, input amplifiers and power supply. Net price \$79.50. Model CRB is not provided with sweep circuit. Lists at \$69.50. Both are equipped with 3-in. cathode ray tubes.

Electronic Switch. An electronic switching device for comparing on a standard cathode ray oscillograph the wave form and phase of two voltages or currents in different parts of the same circuit is announced by the Allen B Dumont Laboratories, Upper Montclair, N. J., under the name Type 150 Electronic Switch. The device has

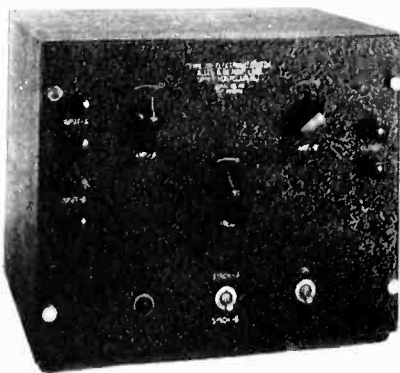

no mechanically moving or vibrating parts, and consists of a switching tube and two amplifiers, one amplifier for each wave form applied. The list price of the complete unit is \$42.50; and operates on 110 volts, 60 cycles, a.c., and is completely self-contained.

Piezo Electric Calibrator. The RCA Parts Division, Camden, N. J., announces a Piezo-Electric Crystal Oscillator, of guaranteed accuracy 0.5 per cent, with a crystal calibration of two



parts in one million, capable of checking frequencies from 100 kc. to 20,000 kc. in 100 kc. steps and from 1,000 kc. to 500 kc. in 1,000 kc. steps. The net price is \$29.95, complete with crystal, tubes and power supply. Uses an acorn type tube. Measures 5½ x 3¾ x 2½ in., and weighs 1 lb. 3 oz. Power consumption is 2 watts. Designed for calibrating test oscillators, receivers and other equipment.

Capacity Meter—The Weston Electrical Instrument Corporation, Newark, N. J., announces a new multi-range capacity meter providing full scale ranges of 10, 1, 0.1 and 0.01 micro-



farads, with a minimum reading as low as 100 micromicrofarads. The device operates directly from 110 volts 60 cycle, a.c., and weighs approx. 1½ lb.

Universal Instrument. A Universal a.c. and d.c. voltmeter and ammeter, under the name Universal Polyrange is announced by the Sensitive Research Instrument Corp., 4545 Bronx Blvd., New York City. Contains 27 internal ranges with full scale readings of from 200 microamperes to 1,000 milliamperes d.c., 10 milliamperes to 3 amperes a.c., two millivolts to 1,000 volts d.c. (1,000 ohms per volt) and .3 to 1,000 volts a.c. (100 ohms per volt). External

multipliers may be used to increase the voltage ranges to 30,000 volts and the current ranges to 300 amperes. List price is \$165.

Light Indicator. A small illumination meter providing a range from 0 to 250 footcandles without the use of multiplying accessories. Weight 7 oz., measures 2½ in. by 2½ in. by 1½ in. The light-sensitive element is contained in the face of the meter. Manufactured by the Weston Electrical Instrument Corp. for the Sight Light Corp. Suitable for light measurements by the layman, in schools, by salesmen and in the home.

Adjustable Decade Resistance Box. An adjustable resistance unit for general laboratory or shop use is announced by the Muter Company, Chicago. It is designed to an accuracy of approximately ½ of one per cent. Four different resistance boxes are built, each with a different resistance value. By using a combination of two of these boxes, it is possible to obtain any resistance from 1 ohm to 111,111 ohms in steps of 0.1 ohm. Useful for routine testing and in class room construction.

Exposure Meter: The Weston Electric Instrument Corp., Newark, N. J., has announced a new photo-electric exposure meter which will accommodate a range of brightness from ¼ to 1,000 candles per square foot on a single scale, and using a re-designed microammeter having an increased deflection at the lower end of the scale.

Miscellaneous Equipment

Aviation Beacon Receiver. A radio beacon aircraft receiver, designed by the Radio Frequency Laboratories, Inc., designed to operate on beacon signals of the Department of Commerce Radio system is announced for sale by Seabury & Sons, Inc., Boonton, N. J. Frequency range 194 to 420 kilocycles.

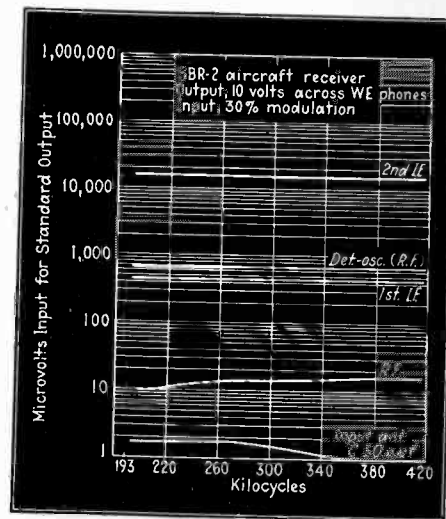

Weight with dynamotor 14 lb. The list price with accessories is \$98. Will operate with either low or high impedance headphones and will receive bea-

SHAKEPROOF



The New Cars are SHAKEPROOF of course!

IT seems the new cars have reached a zenith. Such performance! Such riding comfort! And, at prices so surprisingly low! Shakeproof is happy to have played a part in this great display of automotive progress and is proud that the industry has specified Shakeproof Lock Washers for an even greater number of applications than ever before. The engineers who are designing and building these great cars know from years of experience that Shakeproof's multiple-locking washers never let go—that each twisted tooth, biting into both nut and work surfaces, positively stops any backward movement of the nut. That is why they depend on Shakeproof to keep important connections tight and thus assure the utmost in performance.

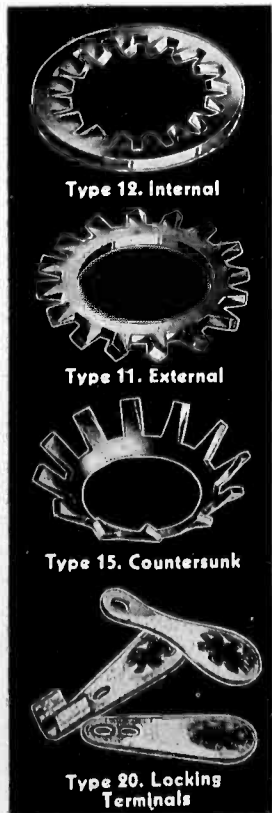

SHAKEPROOF

Lock Washer Company

U. S. Pat. 1,419,564—
1,604,122—1,697,954
1,782,387
Other Pat. Pending—
Foreign Pat.

Distributors of Shakeproof Products
Manufactured by Illinois Tool Works
2539 N. Keeler Ave. Chicago, Ill.

TRIPLET

INSTRUMENTS ARE *Distinctive* Modern EXTERNALLY

PRECISION WITHOUT EXTRAVAGANCE

At right is shown a 4" square **TRIPLET MILLIAMMETER** — Not its modern style. All Triplet instruments show this up-to-date smart appearance. They are accurate, easy to read and compact in size.

In the laboratory, on the panel or installed as standard equipment on electrical machinery, they add distinction and up-to-date efficiency.

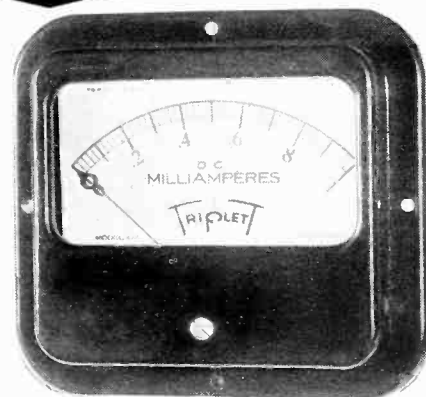

Precision Built INTERNALLY

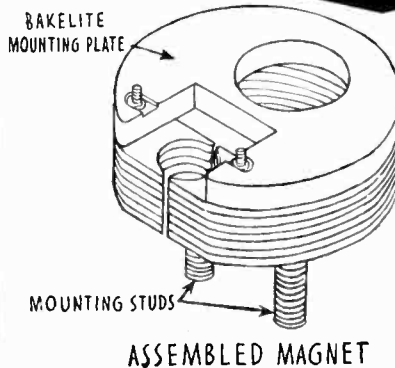

The Triplet magnet construction is shown at left. Not one piece, any more but seven separate segments—each segment of selected stock, punched, hardened, peened and gauged for precision accuracy.

This method of magnet construction definitely insures greater production accuracy, and non-changing characteristics which is but one of the many reasons Triplet instruments meet today's needs of the exacting engineer.

For a new conception of precision instruments, use Triplet.

TRIPLET MANUFACTURES

A complete line of electrical measuring instruments for radio, electrical and general industrial purposes both standard and custom built. If you have an electrical instrument problem, write to TRIPLET.

TRIPLET

Precision

ELECTRICAL INSTRUMENTS

MAIL THIS COUPON

Triplet Electrical Instrument Co.
2312 Harmon Ave., Bluffton, Ohio

Please send me new 1936 Triplet Catalogue with Prices.

Please quote on enclosed specifications.

Name

Address

City State.....

con signals up to 200 miles under average conditions and up to 500 miles under favorable conditions.

Line Contactors. An alternating current magnetic contactor of 100, 150 and 300 ampere capacity for built-in use is announced by The Electric Controller & Mfg. Co., 2700 East 79th St.,

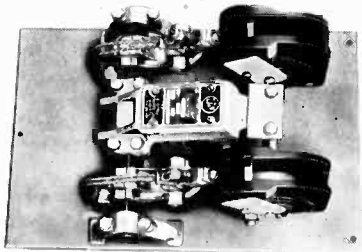

Cleveland, Ohio. Built in single, double and triple pole styles. When the circuit is broken the arc is immediately removed from the contacts and transferred to an arcing plate and blow-out guard.

Motor Starters. A series of d.c. automatic motor starters described in several bulletins of the Ward Leonard Electric Co., Mount Vernon, N. Y. Supplied with or without dynamic brake, reversing or non-reversing, and of the across-the-line, counter E.M.F. or current limit, or time limit type.

Electronic Timer. An instrument for giving direct readings in terms of thousandths of a second by electronic means is announced by the General Electric Co., Schenectady, N. Y. A condenser



is charged at a known rate during the time interval and the voltage on the condenser is then measured by means of a vacuum tube voltmeter, arranged in a bridge circuit. The timer is arranged in a compact box suitable for operation from 115 volts, 60 cycle, a.c. or 125 volts direct current. Time values are obtained by simple conversion of the voltmeter reading.

Pen Recorder. An automatic multiple pen recorder for recording the time, duration, number and sequence of electrical or mechanical operations is announced by the Automatic Electric Co., 1033 West Van Buren St., Chicago. The device contains twelve separate independent recording pens, each capa-

ble of a short transverse motion, which records the operation of the circuit to which it is connected.

Beat Oscillator. A beat frequency oscillator for use in all-wave super-heterodynes having an I.F. between 415 and 700 kc., mounted on a chassis with connecting leads as required. Uses a 58 or 6D6 tube, has controllable pitch. Lists for \$7.50. Stock No. 9606. Manufactured by the RCA Manufacturing Co., RCA Parts Division, Camden, N. J.

Wire Grips—The Bull Dog Electric Products Co., 7610 Jos. Campau Ave., Detroit, Mich., announces a new solderless lug, under the name Bull Dog Wire Grip, which may be attached to any



size wire from No. 14 to 1,000,000 circular mils, in 5 sizes. A "cold flowed" process preserves the structure of the metal of the lug and increases its mechanical strength.

Combination Welder and Trimmer. The Eisler Engineering Co., Inc., Newark, N. J., announces a combination welder and trimmer for working flexible shafts, wire and cable. The welder operates on 110 or 220 volts a.c. and may be mounted on a bench or furnished with a movable pedestal. The machine will handle square or round solid rods, wire and shafts up to $\frac{1}{4}$ in. diameter.

Temperature Control Unit. A temperature control unit for use in dead air spaces where it is necessary to keep the temperature from exceeding any predetermined limit is announced by the Edison Electrical Controls Division of Thomas A. Edison, Inc., West Orange, N. J. The control unit consists of a glass-enclosed thermostat capable of carrying up to 400 watts.

Corrugated Cardboard—A two-ply corrugated cardboard suitable for packing cases is announced by David Weber & Co., 3500 Richmond St., Philadelphia. Known as Cross-Ply Corrugated, this board has the grains of the corrugations at right angles running in two directions.

All-Wave Tuner. An all-wave super-heterodyne tuner of high fidelity design, with metal or glass tubes

optional, tuning range from 12 to 2,100 meters. Manufactured by the Wilco Radio Company, 27-26 Northern Blvd., Long Island City, N. Y.

Auto Antenna. An auto antenna for mounting underneath the running board is announced by Schiffmann Bros., Chicago, Ill., distributed by the Victory Manufacturing & Distributing Co., 3104 S. Michigan Ave., Chicago, Ill. The antenna, which is priced at \$2.75, is constructed of sturdy piping.

Literature

THE following catalogs and manufacturers' bulletins have recently been received.

♦ **Generator Service.** Ideal Universal Mica Undercutter, a technical bulletin distributed by the Ideal Commutator Dresser Co., Sycamore, Ill., describing electrically driven tools for servicing and repairing commutators on rotating machines.

♦ **Radio School.** Practical Radio Engineering, a bulletin of the Capitol Radio Engineering Institute, Washington, D. C., describing courses both for residence and home study in radio engineering, operating, etc.

♦ **Vibrators.** "The Electronic Parade," a bulletin of the Electronic Laboratories, Inc., Indianapolis, Ind., describing a full line of replacement vibrators for use in automobile power supplies, also vibrator testers and electronic converters.

♦ **Antenna Systems.** Taco Store Demonstration Antenna Systems, a bulletin describing the demonstration of all-wave noise reducing antennas for retail sale.

♦ **Tube Chart.** Sylvania Interchangeable Tube Chart, showing types manufactured by the Hygrade Sylvania Corp., and giving equivalent types of other manufacturers.

♦ **Condensers.** "Cornell Capacitors," a bulletin of the Cornell-Dubilier Corp., 4377 Bronx Blvd., New York City. Containing ratings and prices, mechanical dimensions of the complete line of C-D condensers both of the electrolytic, paper and mica types.

♦ **Molded Products.** A folder "Synthane Laminated Bakelite for Mechanical Application," descriptive of the essential physical, electrical, chemical and mechanical properties of synthane, especially as used in mechanical applications.

♦ **Telephone Equipment.** Automatic Electric Review, September 1935 issued by the American Automatic Electric Sales Co., Chicago, U. S. A. descriptive of telephone equipment and automatic pen recorders.

NEW! RADIO RECEPTOR DYNAMIC (MOVING COIL) MICROPHONES



The high sensitivity of these microphones reduces amplifier cost, parasitic and tube noises.

MODEL 6-A

especially designed for studio broadcasting and recording work.

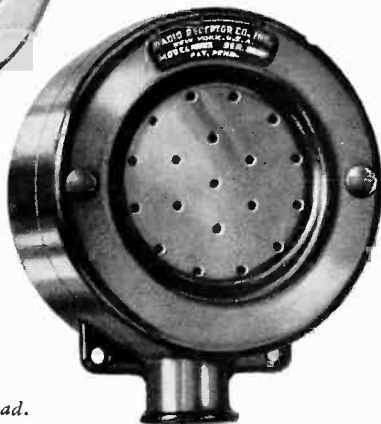

MODEL 6-B

for remote pickup and public address work.

MODEL 6-C

for amateur use and low-priced public address equipment.

LIST PRICE \$30.00 AND UP

Please reply on your letterhead.
We will gladly send complete information.

RADIO RECEPTOR COMPANY, INC.
108 7TH AVENUE, NEW YORK CITY, U. S. A.

There must be a reason for the popularity of AMERTRAN MODULATION SETS

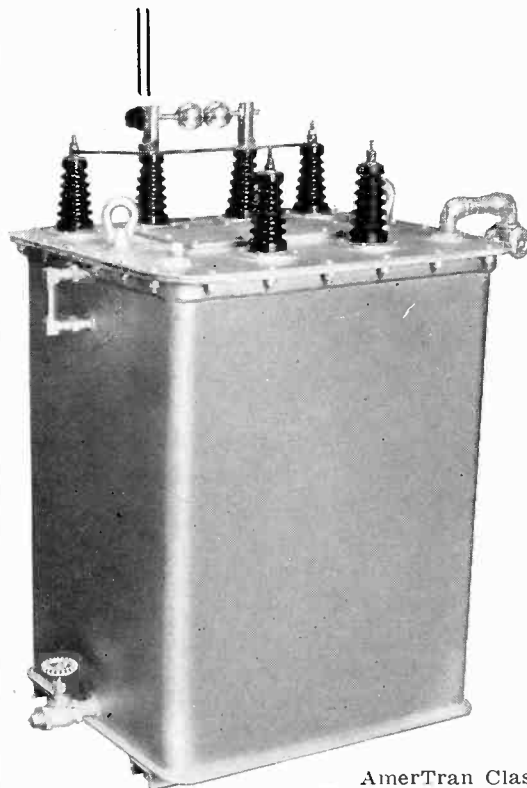

AmerTran Class
"B" Output Trans-
former for +65 dB
level.

WITHOUT fear of contradiction, AmerTran is proud to claim that it has furnished a large majority of all class "B" modulation sets used in the larger American broadcast stations. Such equipment has been supplied to all sizes of stations from 100 watts to 500 kilowatts.

The successful results obtained with AmerTran equipment explain its great popularity. Actual tests on these transformers show an insertion loss of less than 1 dB and frequency characteristics uniform within ± 1 dB from 30 to 16,000 cycles.

May we send engineering details on a modulation set to meet your needs?

AMERICAN TRANSFORMER CO.

Transformer builders for over 34 years
180 EMMET ST., NEWARK, N. J., U. S. A.

FERRANTI

High Fidelity Audio Components

for:

- Amplifiers
- Low and High Frequency Class A Amplifiers
- Class B Amplifiers
- Low and High Pass Filters
- Band Pass Filters
- High Q Inductors
- High Quality Inductors
- Special Transformers
- Power Supplies
- Repeat Coils
- Equalizers

EVERY broadcasting and communications engineer can benefit from Ferranti service. Each unit is custom built by hand. The experience of Ferranti engineers is available for cooperation.

We shall gladly submit recommendations on receipt of details—or quote on your requirements.

FERRANTI ELECTRIC, Inc.
130 W. 42nd St., New York City

QUALITY
SERVICE
QUICK DELIVERY



**AMERTRAN
TRANSFORMERS**



PATENTS REVIEW

Patents indicate trends. Next year's radio circuits, applications of electron tubes for non-communication purposes, new tube types, new materials, may be discovered by following United States and British inventions.

Electron Tube Applications

Exposure meter. A light-sensitive device indicating the proper diaphragm opening and the corresponding exposure time. E. F. Weston, Weston Electrical Instrument Corp. No. 2,016,469.

Horologe system. A. M. Nicolson, Communication Patents, Inc. No. 2,020,039.

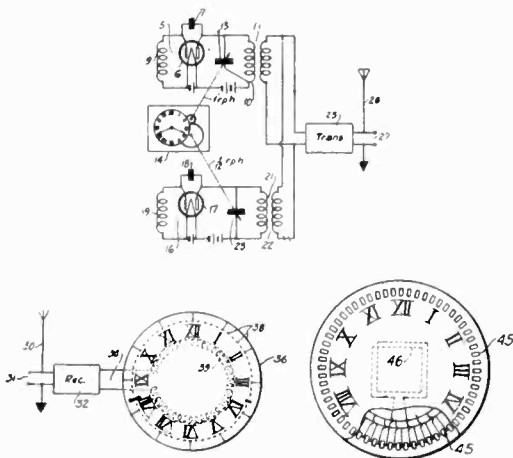

Geophysical apparatus. Method of exploring characteristic differences between different geologic strata traversed by a bore hole, consisting in moving a generator of high frequency oscillations and a radiator through the bore hole to successively expose each stratum individually to the field of force. Oscar Martiensen, Kiel, Germany. No. 2,018,080.

What May Be Patented

THE FOLLOWING DATA is taken from a card of Joshua R. H. Potts, patent attorney of Washington, D. C.

Patents may be granted to anyone for any invention, or discovery of any new and useful art, machine, manufacture, composition of matter, process, method, chemical compound, or medicinal compound if constituting more than a mere physician's prescription, or to anyone who has invented or discovered and asexually reproduced, any distinct, or new variety of plant, other than a tuber-propagated plant (if not introduced to the public prior to May 23, 1930); or any new, original and ornamental design for machines, articles of trade, (etc.) or any other new, original and ornamental design, or any new and useful improvement thereof, not known or used by others in this country, before his, or her, invention, or discovery thereof, and not patented, or described in any printed publication in this, or any foreign country, before his, or her, invention, or discovery thereof, or more than two years prior to the date of the application; and not in public use, or on sale, in this country for more than two years prior to the date of the application; and not patented in any country foreign to the United States on an application filed by him, her, or their legal representatives, or assigns, more than one year prior to the application.

The function, end, or purpose sought to be accomplished by an invention cannot be patented, but the new and useful means for accomplishing such result may be.

Control circuits. Method of using electron tubes to control dynamo electric machine. J. W. Allen, Eclipse Aviation Corp. No. 2,018,107 and 2,018,108. Also, No. 2,020,961 to L. R. Quarles, WE&M Co., and 2,020,942 to F. H. Gulliksen, WE&M Co., on motor regulating systems.

Measuring system. Apparatus using a high frequency oscillator for measuring dimensions or other characteristics of material substances. W. H. Howe, Atlantic Precision Instrument Co. No. 2,018,673.

Automatic tuning system. G. L. Beers, RCA. No. 2,017,523.

Balance timing. Method of continuously observing phase difference between standard impulses and impulses of unknown frequency. A. F. Poole, Ithaca, N. Y. No. 2,019,769.

Current wave indicator. Method of using a dynamic loud speaker diaphragm to which is fixed a small mirror

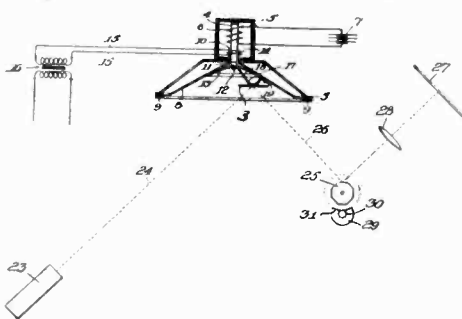

in an electrical oscillograph. W. J. Liska, Berwyn, Ill. No. 2,020,195.

Temperature control. A circuit using two quartz crystals in an oven with means for effecting temperature regulation and producing visible and audible monitoring of the degree of accuracy of such regulation. W. S. Halstead, White Plains, N. Y. No. 2,017,859.

Radio Aids to Navigation

Direction finding system. A system in which televised signals have a distinguishing characteristic for use in a direction finding system. H. M. Dowsett, RCA. No. 2,018,349.

Landing system. Method of guiding aircraft to ground by using two non-coincident electric fields which form an intersecting pattern in the space through which aircraft should pass. R. M. Willette, RCA. No. 2,012,412.

Navigating system. The use of light-responsive cells in a receiving apparatus. J. A. Willoughby, Washington, D. C. No. 2,010,833.

Antenna system. Directional antenna array of three dimensions comprising several spaced simple dipole antenna units arranged in the same vertical plane and oscillating in the same phase, and a similar array oscillating in the same phase with respect to one another but in opposite phase with respect to the radiating antenna. Rudolf Bechmann, Telefunken. No. 2,018,342.

Directional arrangement. Method of obtaining beams of radiation in two different directions comprising a horizontal single wire antenna and a reflector parallel to but spaced vertically a distance away, the projection of the line joining the centers of the two wires upon the desired directions of radiation being made an odd multiple of a quarter wave length. C. W. Hansell, RCA. No. 2,017,047.

Polarized antenna. Aerial of low directional effect and horizontal polarization comprising four conductors forming a square in a horizontal plane

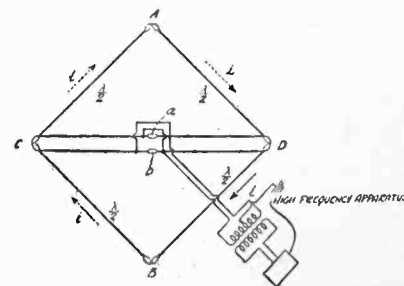

insulated from each other, the length of each conductor being equal to one-half the length of the transmitted wave. Michel Gouriaud, Paris. No. 2,017,121.

REMLER ATTENUATORS

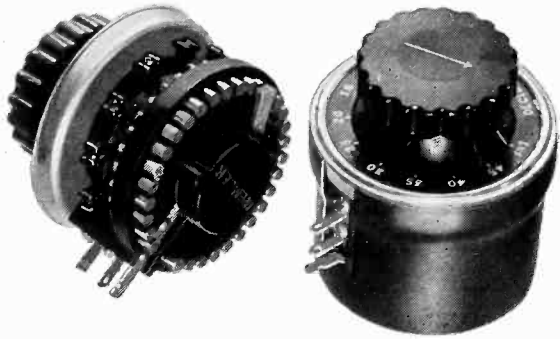

Endorsed by leading Broadcast Engineers

Highly recommended for broadcast apparatus, sound recording and projection equipment. Attenuation variable in 27 steps of 1 2/3 db. per step up to 45 db., fading in 3 additional increasing steps from 45 db. to infinity. Attenuation change halved as switch arm spans adjacent contacts resulting in attenuation of 5/6 db. per step. Impedance practically constant over entire range of the pad. Essentially flat frequency response.

Bakelite covered, moisture-proof bifilar windings. Handles power levels up to plus 24 db. Diameter 2 3/4"; depth back of panel 2 1/16"; mounts 2 3/8" hole or by three 6/32" screws on 1 7/16" diameter circle.

Standard impedances of 50, 200, and 500 ohms. \$10.80
Special values to order. LA-5 Ladder Type. Net

Send for new Catalogue Sheets

REMLER COMPANY, Ltd.

2101 Bryant Street

San Francisco, Calif.

REMLER—THE RADIO FIRM AS OLD AS RADIO

Now Available

**For Broadcasting Stations . . .
A Non-Directional Microphone**

Low price—light weight (only 3 oz.) and small size (4 1/4") make the Brush B2S an ideal instrument for general broadcasting work. Splendid for remote pick-up. No distortion from close speaking. No input transformer, button current or energizing voltage required.

Typical Brush construction insures satisfactory performance and freedom from breakdown and delays. Fewer than 1/10 of 1% of all Brush Mikes have required adjustment or repair of any kind. Fully guaranteed.

The B2S is one of eleven in a quality line that includes studio—general purpose—theatre—desk—lapel and unidirectional instruments. Descriptive literature sent on request. Write for copies today.

only
\$45⁰⁰
List

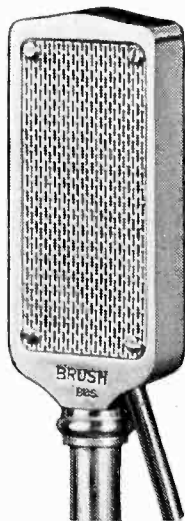

Brush B2S
Microphone

The **BRUSH** DEVELOPMENT COMPANY
PIEZO ELECTRIC
1884 E. 40th St. CLEVELAND, O.
MICROPHONES • MIKE STANDS • TWEETERS • HEAD PHONES • LOUD SPEAKERS

**AS
USEFUL AS**



YOUR WATCH
*and Equally
as Portable*

THE PRESTO INSTANT RECORDER

Compact as the watch in your pocket—as useful, and as accurately engineered to the fraction of an inch, for utility and strength is the precision-built PRESTO INSTANTANEOUS RECORDER. Broadcast stations have called the Instant Recorder a "scientific scoop"—specifying it as part of their high fidelity equipment.

THE RECORDER comes complete in two handsome cases. It can be carried with ease by one man. The portability and flexibility of this unit make it extremely useful in filling countless jobs around the studio and transcription laboratory—jobs that ordinarily would require expensive installations.

Recording Equipment in Its Most Convenient Form

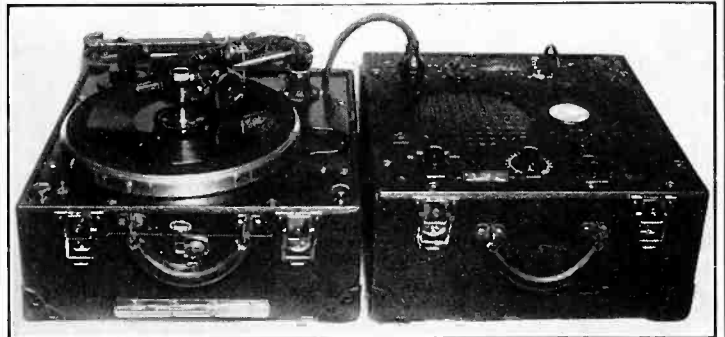

Another noteworthy PRESTO Achievement.

THE GREEN SEAL DISC

NOW—received with general acclaim by the field. Heavy chemically coated disc on an aluminum base—the GREEN SEAL DISC is the result of years of continuous research and development.

The characteristics of these discs are such that many broadcasting stations are using them for transcription purposes.

EVERYTHING FOR RECORDING—FROM A NEEDLE TO A COMPLETE STUDIO INSTALLATION.

Write for latest catalog on disc and reproducer.

PRESTO
RECORDING CORPORATION
139 West 19th Street, New York, N. Y.

Wave antenna. A vertical mast radiator with a relatively large top structure, and antenna wires secured at their upper ends to the outer portion of the top structure and electrically insulated from it, with the wires converging downwardly in electrically spaced relation from the mast and having the lower ends secured to a ground insulator in approximately the center of the mast. C. E. Schuler, International-Stacey Corp., Columbus, Ohio. No. 2,014,785.

Television Systems

Television system. Complete system involving communication by telephone and television between two of several operating stations. V. K. Zworykin. No. 2,017,883.

Color system. Electro-optical apparatus for producing images in natural colors. H. E. Ives, B.T.L., Inc. No. 2,017,659.

Scanning system. A rotary scanning element, etc. M. A. Trainer, RCA. No. 2,017,136.

Mirror Screen. Scanning means comprising a rotatable mirror device having several reflecting surfaces helically positioned about the axis of rotation. Frank Gray, B.T.L., Inc. No. 2,017,092.

Scanning apparatus. Apparatus for picture transmitting system involving means to expose a spot of a sensitive receiving film in accordance with the

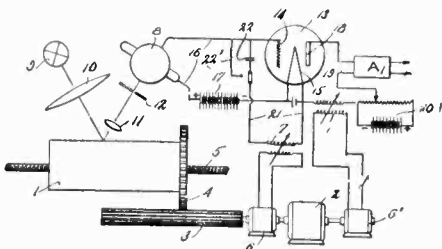

modulated current received from the line from the transmitter and means to move the receiving film in synchronism with the transmitting film. Austin G. Cooley, RCA. No. 2,015,742.

Chemical system. Method of reproducing light and dark points of a picture on a clear chemical ground, the process comprising appropriately inciting evanescent electro-chemical changes at various points in the visual field and clearing such electro-chemical changes on current cessation by a chemical agent initially present. Henry Cunningham, Cleveland, Ohio. No. 2,012,270.

Variable velocity scanning. Rudolph Thun, Germany. No. 2,011,737. (See *Electronics*, November, 1935.)

Light cell method. A system comprising a group of photoelectric cells, a second group of cells each of greater current carrying capacity than those of the first group and connected in series with the first group with a means for

projecting an image of a field of view upon the first group of cells and means for successively activating the cells of the second group. Frank Gray, B.T.L., Inc. No. 2,010,543.

Projection system. Method of making visible images outside of the cathode ray tube on an external fluorescent screen. Alexander Kerr, Berlin, Germany. No. 2,009,498.

Indicating device. Use of a television system as an airplane drift indicator. V. K. Zworykin, RCA. No. 2,013,594.

Patent Suits

1,558,437, I. Langmuir, Electrical discharge apparatus; 1,696,103, G. Seibt, Electrical discharge tube; 1,748,026, L. E. Mitchell, Electron discharge device, filed June 7, 1935, D. C. N. J., Doc. E 5171, *Radio Corp. of America et al. v. Arcturus Radio Tube Co.*

1,811,095, H. J. Round, Thermionic amplifier and detector; Re. 18,579, Ballantine & Hull, Demodulator and method of demodulation; 1,297,188, I. Langmuir, System for amplifying variable currents, filed Aug. 5, 1935, D. C. N. J., Doc. E 5261, *Radio Corp. of America et al. v. Atlas Laboratories, Inc., et al.*

1,354,939, H. D. Arnold, Vacuum tube device; 1,459,412, A. M. Nicolson, Thermionic translating device; 1,479,778, H. J. Van der Bijl, Vacuum tube device; 1,537,708, W. Schottky, Thermionic vacuum tube, filed June 7, 1935, D. C. N. J., Doc. E 5172, *Radio Corp. of America et al. v. Arcturus Radio Tube Co.*

1,544,081, F. K. Vreeland, Transmitting intelligence by radiant energy; 1,778,456, I. Langmuir, Means for producing alternating currents, filed Aug. 12, 1935, D. C., S. D. Calif. (Los Angeles), Doc. E 745-C, *Radio Corp. of America et al. v. Globe Wireless, Ltd., et al.*

1,648,808, L. A. Hazeltine, Wave signaling system; 1,755,114, same, Unicontrol signaling system; 1,755,115, same, Variable condenser, C. C. A., 2d Cir., Doc. 13,556, *Hazeltine Corp. v. Sears, Roebuck & Co., Inc.* Decree affirmed (notice Aug. 16, 1935).

1,707,545, E. C. Wentz, Acoustic device, appeal filed Aug. 19, 1935, C. C. A., 8th Cir. (St. Louis), Doc. 10,347, *Western Electric Co., Inc., et al. v. Cinema Supplies, Inc.*

1,734,624, H. C. Harrison, Piston diaphragm having tangential corrugations, appeal filed Aug. 19, 1935, C. C. A., 8th Cir. (St. Louis), Doc. 10,346, *Western Electric Co., Inc. v. Cinema Supplies, Inc.*

1,329,283, 1,398,665, H. D. Arnold, Thermionic amplifier; 1,349,252, same, Method of and means for utilizing thermionic currents; 1,403,475, same, Vacuum tube circuit; 1,448,550, same, Thermionic amplifier circuit; 1,465,332, same, Vacuum tube amplifier; 1,520,994, same, Electron discharge; 1,453,982, B. W. Kendall, Electrical receiving or repeating apparatus and the method of

operating same; 1,493,595, D. G. Blattner, Amplifying with vacuum tubes; 1,544,921, R. C. Mathes, Amplifier circuit, appeal filed Aug. 19, 1935, C. C. A., 8th Cir. (St. Louis), Doc. 10,345, *Western Electric Co., Inc. et al. v. Cinema Supplies, Inc., et al.*

1,297,188, I. Langmuir, System for amplifying variable currents; 1,573,374, P. A. Chamberlain, Radio condenser; 1,728,879, Rice & Kellogg, Amplifying system, D. C., N. D. Calif. (San Francisco), Doc. E 3895-L, *Radio Corp. of America et al. v. Schwabacher-Frey Co.* Patents held valid and infringed Aug. 7, 1935. Doc. E 3896-S, *Radio Corp. of America et al. v. C. Silverman.* Decree as above. Doc. E 3898-S, *Radio Corp. of America et al. v. Kahn Dept. Stores, Inc.* Decree as above Aug. 5, 1935.

1,777,256, J. C. Daley, et al., Transformer, filed July 5, 1935, D. C., N. D. Ill., E. Div., Doc. 14666, *Jefferson Electric Co. v. Sola Electric Co. et al.*

1,231,764, F. Lowenstein; 1,618,017, same; 1,403,475, H. D. Arnold; 1,465,332, same; 1,403,932, R. H. Wilson; 1,507,016, L. de Forest; 1,507,017, same; 1,702,833, W. S. Lemmon; 1,811,095, H. J. Round; Re. 18,579, Ballantine & Hull, D. C., S. D. Calif. (Los Angeles), Doc. E 78-M, *Radio Corp. of America et al. v. Westone Radio Corp.* Decree for plaintiff, injunction granted Sept. 3, 1935.

1,867,249, Clark & McCann, Electrolytic device; 1,916,586, Robinson & Collins, same; 1,935,860, 1,938,464, P. Robinson, same; 1,948,289, H. I. Danziger, Electrolytic condenser, D. C., S. D. Ohio, W. Div., Doc. E 892, *Sprague Specialties Co. v. Electro Formation, Inc.* Bill dismissed without prejudice Sept. 25, 1935.

1,239,852, F. K. Vreeland, receiver of electrical impulses; 1,544,081, same, Transmitting intelligence by radiant energy; 1,251,377, A. W. Hull, Method of and means for obtaining constant direct current potentials; 1,297,188, I. Langmuir, System for amplifying variable currents; 1,573,374, P. A. Chamberlain, Radio condenser; 1,728,879, Rice & Kellogg, Amplifying system; 1,820,809, E. W. Kellogg, Electrical system, D. C., S. D. Calif. (Los Angeles), Doc. E 77-H, *Radio Corp. of America et al. v. Westone Radio Corp.* Decree for injunction Sept. 17, 1935.

1,710,073, 1,714,191, S. Ruben, Electrical condenser, D. C., S. D. N. Y., Doc. E 68/212, *Ruben Condenser Co. et al. v. Condenser Corp. of America.* Consent order of discontinuance (notice Sept. 28, 1935).

Adjudicated Patents

(C. C. A. N. Y.) Moses patent, No. 1,306,116, for ignition apparatus. Held not infringed. *Electric Auto-Lite Co. v. P. & D. Mfg. Co.*, 78 F. (2d) 700.

(C. C. A. Mass.) Farrand patent, No. 1,855,168, for loud speaker, claims 1, 2 and 5 Held invalid. *Utah Radio Products Co. v. Boudette*, 78 F. (2d) 793.

A MASTER OSCILLATOR TYPE STANDARD SIGNAL GENERATOR

for the
Research and Design Laboratory

For results obtainable only with a master
oscillator type of instrument:

MODULATION to 100% with good quality. Negligible reaction of controls on frequency.

BRIEF SPECIFICATIONS:

Operates from the 115 volt, 60 cycle AC line.

FREQUENCY RANGE: 150 to 20,000 kilocycles. (Additional coils available for 75 to 150 and 20,000 to 30,000 kilocycles.)

OUTPUT: Two volts maximum across LOW RESISTANCE (Never over 20 ohms)

0 to 50,000 microvolts across fixed 5 ohms.
50,000 to 500,000 microvolts across variable zero to 5 ohms
1 volt across fixed 10 ohms
2 volts across fixed 20 ohms.

DIRECT READING system of modulation measurement

Modulation up to 40% using internal 400 cycle oscillator
Modulation up to 100% using external audio source
(Approx. 12 watts audio power required for 100% modulation)

WORM DRIVE tuning condenser with 30 foot scale length for accurate frequency settings.

Price: \$1795.00 FOB Newark, N. J., complete except tubes. Includes coils for 150 to 20,000 kilocycles, and full frequency calibration.

Write for illustrated descriptive circular

FERRIS INSTRUMENT CORPORATION, BOONTON, N. J.



Model 15A Master Oscillator Signal Generator

**FROM
EVERY ANGLE!**



The new Shure Model 74B "Spheroid" NON-DIRECTIONAL Crystal Microphone picks up equally well from every angle! From every side . . . from above or below . . . you get true Wide-Range response to 10,000 cycles.

Higher output level! . . . "Grafoil" crystal for low cable loss! . . . Acoustic streamlining! . . . all these advanced features contribute to its superlative performance.

For complete technical data, write for Bulletin 134M now!



Model 74B, list price only \$37.50—complete with improved plug and convertible receptacle for stand or suspension use.

Licensed under patents of the Brush Development Company. Shure patents pending.

SHURE MICROPHONES
SHURE BROTHERS • MICROPHONE HEADQUARTERS
215 WEST HURON STREET • CHICAGO, U. S. A.

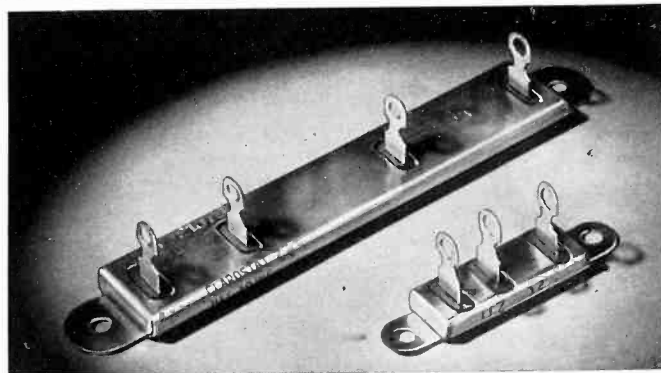

Steel-Clad VOLTAGE DIVIDERS

Neater mechanically . . . better electrically . . . and more uniform. Designed to your exact needs. Built for assemblies that must "stand up." Prompt deliveries.

Wide resistance values up to 10,000 ohms per inch for 3/4" wide. 7000 ohms for 1/2" wide units.

Wire-wound . . . bakelite strip . . . moisture repellent wrapping . . . heavy metal jacket.

Max. safe power dissipation per inch—2 1/2 watts for large, 1 1/4 for small. Also 5 watts in asbestos core units.

Every section bridge tested. Units tested for breakdown at 1000 volts A.C.

DATA General details on request. For samples and quotations, please furnish complete electrical data—current through and voltage drop across each section.

CLAROSTAT
MFG. CO., Inc.

285 North 6th St.

Brooklyn, N. Y.

British Patents

Television

Scanning disc. A scanning disc with apertures arranged in a circle or spiral comprises a glass or celluloid body carrying an emulsion with grains of small size, in which the apertures are formed photographically by a process either of reversal or of physical development. Optical images of an illuminated aperture or of a dark spot in an illuminated field are cast upon the disc as it is rotated by intermittent illumination. Baird. No. 425,615.

Scanning system. To prevent visible return lines on the screen of a cathode ray tube with scanning controlled by relaxation oscillations produced by the use of a grid-controlled discharge tube, the ordinary discharge of a condenser is interrupted at the beginning of the slow part of the discharge curve which produces a corresponding visible path on the screen. This is done by supplying to the oscillating circuit a counter e-m-f at least as great as the potential of the condenser at that time. D. S. Loewe. No. 425,685.

Cathode ray system. A cathode ray scans a mosaic photoelectric screen on which is projected a cinema film. This projection takes place during only one-tenth of the cycle of operations, and

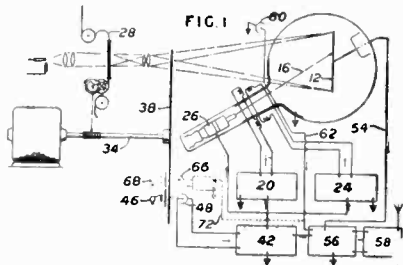

scanning is effected during only the remaining nine-tenths of the cycle. Movement of the film occupies one quarter of the cycle and occurs during the scanning period when the film is not being projected. R. D. Kell, Marconi Co. No. 431,207.

Oscillograph circuit. In a cathode-ray oscillograph, particularly for television use, in which the time base circuit comprises a tube, a condenser and an inductance, the inductance is located with respect to the oscillograph so that its magnetic field deflects the cathode ray off the screen during the return strokes. G. E. Co. No. 423,963.

Scanning system. Scanning equivalent to that produced by saw-tooth wave-forms is obtained by deflecting each of several cathode rays with sinusoidal oscillations, the oscillations being of equal frequency but phase displaced relatively to each other. G. E. Co. No. 424,093.

Screen. The image of an object to be transmitted is formed on a luminescent screen scanned by radiation,

such as cathode or ultra violet rays, and associated with light-sensitive means to produce the picture signals. Baird Television. No. 424,199.

Cathode ray system. A high-frequency oscillation of small amplitude is superimposed on the image-frequency scanning oscillation so that the cathode ray performs rapid vertical oscillations along each line. The apparent thickness of the line is therefore maintained constant. No. 428,926.

Frequency reduction. The band-width in television-transmission is reduced by heterodyning the picture signals with an oscillation rich in harmonics and of slightly different frequency. The resulting frequency band comprises a fundamental and harmonics equal to the difference frequencies, the highest of which is arranged to be less than the fundamental line frequency. At the transmitter the picture signals and the local oscillation and harmonics are passed through a square-law rectifier or demodulator which yields the required narrow band of frequencies. At the receiver this band is heterodyned with a local oscillation of suitable wave-form by means of a detector having a square-root law. The signals are thus translated back into their original form. Marconi Co. No. 430,161.

Light valve. A crystal whose double refraction varies with the applied electric field is associated with a second crystal which compensates for the initial double refraction of crystal No. 1, so that light passes through the two crystals without deflection. D. S. Loewe. No. 427,092.

Oscillator circuits. Curvature in the charging-curve of a condenser in a relaxation-oscillation generator is corrected subsequently by amplifying the oscillations by a pentode working on the bottom bend of its characteristic curve. D. S. Loewe. No. 425,686. See also No. 425,687.

Scanning system. Scanning is performed by several refractively acting laminae moving about an axis perpendicular to their planes. The laminae are angularly displaced relatively to one another and are semi-cylindrical with the cylindrical surface in a circle about the axis. G. Walton, London. No. 425,984.

Cathode-ray system. In a system wherein the intensity of the beam is controlled by potentials applied to a control electrode substantially symmetrical with respect to the axis of the beam, the picture modulation in the tube is effected by amplified signal modulated high frequency or intermediate frequency energy which is applied directly to the control electrode without previous demodulation. The carrier frequency applied to the tube

is at least twice the highest picture point frequency and the amplification of the signal modulated energy is effected by one or more multi-grid valves. Telefunken. No. 426,173.

Velocity modulation. In a system of this type, a voltage derived from the output of the photocell and controlling instantaneous rate of changes of scanning ray, is transmitted and the integration to produce the voltage controlling the deflection of the ray at the receiver is carried out by a time-base circuit at the receiver. A. C. Cossor. No. 427,625. See also No. 427,630 on a means for accentuating higher frequencies in a velocity modulating system.

Cathode ray system. Synchronizing signals are derived from the scanning currents for a cathode ray tube. The voltage waves across deflecting coils comprise a saw-tooth component and a positive impulse component and are applied to the grids of two tubes. These tubes are biased negatively

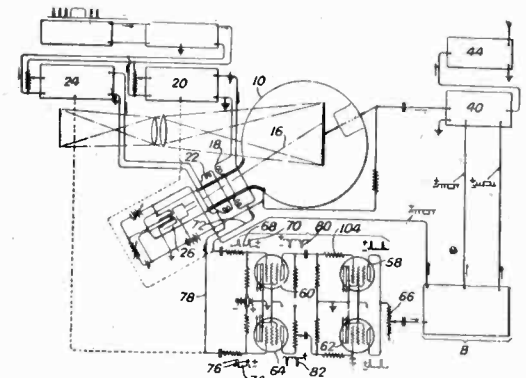

beyond cut-off and the synchronizing impulses in their plate circuits are negative impulses of an amplitude corresponding to plate saturation. Marconi Co. No. 428,168.

Photographic process. In a rapid photographic process for television purposes the subject is recorded upon a silver halide gelatine emulsion so hardened that it has a melting-point at least 35 deg. C. and the exposed material is developed within 3 to 30 seconds in a developing bath heated to at least 40 deg. C. After rapid fixing and washing, the film is freed from water by a concentrated salt bath, for example, magnesium sulphate, and is passed between deerskin rollers after which it may be scanned. W. W. Groves, London. No. 428,382.

Film system. The signals are derived from cinema film having an intensity contrast substantially less than 1:8 which represents the intensity contrast of normally developed films. The object may be photographed on a film which is treated to produce a negative with an intensity contrast considerably greater than unity and preparing from the negative a positive with a lower intensity contrast than the negative and employing the positive for transmission. E&MI. No. 428,852.

Index to **electronics**—Volume VIII

January to December issues, inclusive, 1935

McGraw-Hill Publishing Company

330 West 42nd Street, New York City

Pages by Issues

January	1-36
February	37-70
March	71-106
April	107-140
May	141-172
June	173-204
July	205-236
August	237-268
September	269-332
October	343-414
November	415-498
December	499-556

(ed) Editorial • Illustrated

Acoustics:

Dramatic use of controlled sound. Noel Urquhart	252
Königsberg studio's acoustics	121

Aeronautics:

Aircraft radio compass	349
Microwaves to detect aircraft	284

Amplifiers:

Adjusting the class B linear power amplifier. L. B. Hallman	219
Automatic bias generation for a-c amplifiers. V. V. Gunsolley	191
Design of two-tube microphone amplifier. Paul Von Kunits	512
Flux balancer for output transformer. E. R. Meissner	161
Light sensitive cell circuits. Samuel Wein	530
Multi stage photocell current amplifier. Walter Richter	245
Resistance coupling for push-pull amplification. Walter Richter	382

Antenna:

Antenna terminations. C. G. Dietsch	280
Calculation of vertical antenna radiation patterns. E. A. Laport	46
Problem of auto radio antennas	41
Ultra-high frequency antenna terminations. W. C. Tinus	239
Book reviews	26, 132, 164, 196, 251, 296, 456, 529

Broadcasting:

Automatic volume expander. W. N. Weeden	184
Broadcast maintenance costs	439
Crystal microphone design for single direction pickup. Williams & Arndt	242
Electronic fader. V. V. Gunsolley	58
Filtering for double radiation. Victor Andrew	355
Four stage pickup for golf broadcast	306
High fidelity standards of the Federal Communications Commission	127
High fidelity technique	6
The new KYW station	36
New WOR station	36
Play back recording methods for broadcasting. W. E. Schrage	179
Practical time signal system for broadcasting. H. J. Mayer	246
Present day status of broadcast synchronizing	174
"Re-diffusion" broadcasting in Europe	44
7-meter broadcasting at WBEN-W8KH	114
Some possibilities of synchronizing	177
Standard frequency broadcast schedule revised	379
Suggestions concerning FCC high fidelity standards	191

U. S. Coast Guard's emergency truck	20
WLW installs "blind spot" antenna array	152
"Zero level." W. N. Weeden	361
Oampbell, Dr. G. A., retires	522

Canada Radio Broadcasting Commission:

Installs short wave receiver for British programs	308
---	-----

Cathode Rays:

Cathode ray tube applications. J. M. Stinchfield	153
Elimination of distortion in cathode-ray tubes. A. B. DuMont	16
Modulation measurements by cathode-ray tube	23
Self-protecting cathode. E. F. Lowry	520
Signal synchronized sweep circuit for cathode-ray oscillography	158

Color:

Electronic color organ changes colors in lighting dome	122
--	-----

Electron Tubes—Application:

Applications of electron tubes to finding, refining, using oil, and measuring its quality	509
Electron tube telemetering. E. G. Watts	50
Electronic engine indicators. Ivan Bloch	212
New thermionic motor speed regulator. C. B. Norris	244
Survey of applications of electron tubes	2
Tubes enter the automobile plant. R. A. Powers	276

Electronics:

Diffraction of electrons. C. J. Phillips	290
Electronics laboratory for technical students. T. S. Gray	86

Facsimile:

Associated Press opens wire-photo system	9
Watch ticks analyzed to locate errors	220
Filter curves for power supply (chart). W. W. Waltz	523

High Frequencies:

Frequency modulation advances	188
Microwaves to detect aircraft	284
Microwave transmitter	308
60 Mc. M.O.P.A. C. J. Franks	375
Uses for high frequency power	368

Institute of Radio Engineers:

Fall meeting	505
Report of Detroit convention	206
Manufacturing review	318, 394, 466, 542

Measurements:

A. C. Bolometer	452
Cold-cathode oscillator drives power tube in transmission test	22
Electrolytic capacitor testing in production. P. M. Deeley	216
Electron-tube telemetering. E. G. Watts	50
Electronic voltmeter for d-c arc welding	82
Generating sine waves with a gas discharge tube. W. E. Koch	92
High resistance measurement with vacuum tubes. Albert Preisman	214
High speed direct reading frequency meter	224
Millionths of an inch measured with an electronic relay	160
Modulation measurement by cathode-ray tube	23
Neon tube condenser tester. G. H. Browning	22

Network resistances. R. E. Blakey	447
Oscillator locates faults in high tension transmission line	454
Photocell used for spectroscopy measurements	58
Radio research in 1934	538
Signal synchronized sweep circuit for cathode ray oscillography	158
Thermocouple used in low voltage tube voltmeter. Charles Murray	190
Universal network chart	84
Values of Q for various component parts	126

Music:

Electric organ based on alternator principle	156
Four-part sound film used for chorus instruction	91
WCAU's photocell organ	123
New products	31, 66, 101, 134, 167, 197, 231, 263, 390, 543

Noise:

Commercial noise meters	113
Movement for noise abatement	108
Noise measurement methods	110
Transportation noise studied by new analyzer	90

Patents:

British patents	36, 106, 140, 172, 268, 330, 408, 480, 552
Electronic license situation	142
U. S. patents	34, 69, 104, 137, 170, 199, 234, 266, 320, 404, 427, 476, 550

Photo-Electric Cells:

Photo-voltaic cells in compound circuits. E. D. Wilson	118
--	-----

Photo-Electric Cell—Industrial Applications:

Cigars wrapped with photo-tube's aid	157
Color control in bakery	220
Electronic voltmeter for d-c arc welding. W. Richter	82
Multi-stage photocell current amplifier. Walter Richter	245
"Petoscope." A. S. Fitzgerald	368
Phototubes perforate U. S. stamps. Leonard Church	293
Questionnaire for proposed photo-electric installation	20
Sets type from teletype copy	54
Space detector locates concealed weapons	157
Store lighting regulated by photo-tube	304
Temperature regulator. C. E. Weiland	224
Thermionic delay relays for cathode protection. Miles & Moraek	124
Watermarks centered by photo-cell	21

Public Address:

Public address on S.S. Normandie	367
----------------------------------	-----

Radio:

Automobile radio 1935 model	146
Building bridges by radio. D. R. Tibbets	273
Centromatic unit	358
Dial mechanisms	435
Electrolytic capacitor testing in production. P. M. Deeley	216
High speed radio production. P. H. Jeryan	515
Manufacturers' sales of radio sets, 1932-1934	1
Multi-band r-f choke coil design. H. P. Miller, Jr.	254
Phase frequency modulation	431
Pricing radios by formula	120
Progress of the radio art	202

Radio art advances told at IRE in convention	206	Manufacturing technique of tubes. Metcalf & Beggs	149	Lee, Reuben. R-F insulator voltage limits	353
Radio control room aboard the Normandie	218	Measured input losses of vacuum tubes. C. J. Franks	222	Livingood, John J. Radio activity by bombardment	421
R-F insulator voltage limits. Reuben Lee	353	Metal tube base diagrams and characteristics	302	Lowry, E. F. Self-protecting cathode	520
Salaries paid radio set engineers	8	Phototubes for testing power tubes	253	MANKE, ARTHUR G. Beat oscillators for modern radio receivers	88
Super-regeneration using the pentagrid converter. R. O. Williams	126	Radio receiver and tube sales increase	72	Mayer, Herbert J. Practical time signal system for broadcasting	246
What's new in radio for 1936?	286	Secondary emission electron multipliers	424	McArthur, E. D. Magnetic control of thyratrons	12
X-rays examine radio tubes. R. C. Woods	190	Super regeneration using the pentagrid converter. R. O. Williams	126	Meissner, Earl R. Flux balancer for output transformer	161
Radio Manufacturers Association:		Tube capacity put to work. Hollywood & Wilder	372	Messing, Edgar. Coil testing methods for use in radio plants	248
Work of engineering division. Baker, Graham	78	Vacuum tubes—three circuits for performing control functions	304	Metcalf, G. F., and J. E. Beggs. Manufacturing technique	149
Receivers:		Vacuum Tubes—Industrial Applications:		Miles, L. D., and M. M. Morack. Thermionic delay relays for cathode protection	124
Advancements in ac-de design. Paul Ware	14	Discharge tube circuit used in study of brain	379	Miller, Herman P., Jr. Multi-band r-f choke coil design	254
Beat oscillators for modern radio receivers. A. G. Manke	88	Electronic interrupter. J. H. Hanly	449	Morack, M. M., and L. D. Miles. Thermionic delay relays for cathode protection	124
Bibliography on super-regeneration	30	Industrial high frequency power. H. V. Noble	364	Murray, Charles. Thermocouple used in low voltage tube voltmeter	190
Coil testing methods for use in radio plants. Edgar Messing	248	Radioactivity by bombardment. J. J. Livingood	421	NOBLE, H. V. Industrial high frequency power	364
Crystal coupling for high quality i-f circuits	256	X-Rays:		Norris, C. Boyd. New thermionic motor speed regulator	244
Dial mechanisms	435	Radio tubes examined by X-rays. R. C. Woods	190	PHILLIPS, C. J. Diffraction of electrons	290
European 1935-1936 six-tube superheterodynes	390			Powers, R. A. Tubes enter the automobile plant	276
German receiver designs. W. E. Schrage	388			Preisman, Albert. High resistance measurement with vacuum tubes	214
New radio receiver construction	145			RICHTER, W. Electronic voltmeter for d-c arc welding	82
Radio receiver and tube sales increase	72			Multi-stage photocell current amplifier	245
Signal-seeking circuits to aid correct tuning. S. Y. White	18			Resistance coupling for push-pull amplification	382
Super-regeneration of an ultra-short-wave receiver	312			SCHRAGE, W. E. Developments in German receiver design	388
Tests on r-f circuit hook up wire. R. G. Zender	257			Play back recording methods for broadcasting	179
Variable selectivity superheterodyne	180			Sinnett, C. M. Practical volume expansion	428
Recording:				Stinchfield, J. M. Cathode-ray tube applications	153
Automatic volume expander. W. N. Weeden	184			TIBBETTS, D. REGINALD. Building bridges by radio	273
Increasing disc recording and playing time. Bernard Ephraim	380			URQUHART, NOEL. Dramatic use of controlled sound	252
Play-back recording for broadcasting. W. E. Schrage	179			VON KUNITZ, PAUL. High gain simplified	512
Practical volume expansion. C. M. Sinnett	428			WALTZ, W. W. Power supply filter curves (chart)	523
"Proof-read" recording	533			Ware, Paul. Advancements in ac-de design	14
Review of electronic art here and abroad. 27, 63, 98, 130, 164, 194, 228, 260, 310, 386, 458				Watts, E. G. Electron-tube telemetering	50
Sound Pictures:				Weeden, W. N. Automatic volume expander	184
Engraved sound tracks for film recording	52			"Zero level"	361
Hand drawn sound	448			Wein, Samuel. Light-sensitive cell circuits	530
High speed photography in motion pictures	500			Weinland, C. E. Photocell temperature regulator	224
Stratosphere exploration	525			White, S. Y. Signal-seeking circuits to aid correct tuning	18
Stroboscope. Edgerton, in microscopic photography	94			Wilder, Marshall P., and J. M. Hollywood. Tube capacity put to work	372
Superheterodyne:				Williams, A. L., and J. P. Arndt. Crystal microphone design for single direction pickup	242
Variable selectivity superheterodyne	180			Williams, R. O. Super-regeneration using the pentagrid converter	126
Television:				Wilson, E. D. Photo-voltaic cells in compound circuits	118
Chemical materials used in television apparatus	306			Woods, Robert C. X-rays and metal radio tubes	190
Co-axial television cable authorized (ed)	258			ZENDER, RAYMOND G. Tests on r-f circuit hook-up wire	257
German government aids television	10				
Million-cycle co-axial cable for television	189				
Television scanning—a survey. R. F. Davis	444				
Television transmitters planned	204				
Text of British television report	78				
Thyratrons:					
High tension d-c transmission	56				
Magnetic control of thyratrons. E. D. McArthur	12				
Novel characteristics of tube commutated 400-hp. motor	54				
Thyratron motor used in fan drive	304				
Traffic Control:					
Phototubes used for catching speeders	59				
Transformers:					
Charts for transformer design	356				
High tension d-c transmission	56				
Tubes:					
All metal receiving tubes	116				
All metal receiving tubes	148				
Coordinates for the metal tubes (chart)	301				
High resistance measurement with vacuum tubes. Albert Preisman	214				
Making metal tubes	297				
		ANDREW, VICTOR. Filtering for doubts radiation	353		
		Arndt, J. P., and A. L. Williams. Crystal microphone design for single-direction pickup	242		
		BAKER, W. R. G. Work of engineering division	78		
		Beggs, J. E., and G. F. Metcalf. Manufacturing technique	149		
		Blakey, R. E. Network resistances	447		
		Bloch, Ivan. Electronic engine indicators	212		
		Browning, Glen H. Neon tube condenser tester	22		
		CHURCH, LEONARD. Phototubes perforate U. S. stamps	293		
		DAVIS, ROBERT F. Television scanning—a survey	444		
		Deeley, Paul Macknight. Electrolytic capacitor testing in production	216		
		Dietsch, Carl G. Antenna terminations	280		
		DuMond, Allen B. Elimination of distortion in cathode-ray tubes	16		
		EPHRAIM, BERNARD. Increasing disc recording and playing time	380		
		FITZGERALD, ALAN S. "Petoscope"	368		
		Franks, C. J. Measured input losses of vacuum tubes	222		
		60 Mc M.O.P.A.	375		
		GRAHAM, VIRGIL M. Work of engineering division	78		
		Gray, Truman S. Electronics laboratory for technical students	86		
		Gunsolley, Verne V. Automatic bias generation for a-c amplifiers	191		
		Electronic fader	58		
		HALLMAN, L. B. Adjusting the class B linear power amplifier	219		
		Hanly, James H. Electronic interrupter	449		
		Hollywood, John M., and M. P. Wilder. Tube capacity put to work	372		
		JERYAN, PUZANT H. High speed radio production	515		
		KOCH, WINSTON E. Generating sine waves with a gas discharge tube	92		
		LAPORT, EDMUND A. Calculation of vertical antenna radiation patterns	46		